

FLUKE®

Reliability

VIBXPERT® EX

db® PRÜFTECHNIK

Operating instructions

VIBXPERT® EX

Dual channel
FFT data collector and
signal analyzer with
intrinsic safety

Operating instructions

Series: VIB 5.300 EX

Firmware: 2.3x

Edition: January 2017

Order no.: VIB 9.805.G

Translation of the german manual

LEGAL NOTES

Copyright

Both this manual and the product it describes are copyrighted. All rights belong to the publisher. The manual may not be copied, reproduced, translated or made accessible to a third party in any form, neither in its entirety nor as an excerpt.

Disclaimer

No liability may be claimed against the publisher regarding the product described in this manual. The publisher assumes no liability for accuracy of the manual contents. Furthermore, under no circumstances may the publisher be held liable for direct or indirect damage of any kind resulting from use of the product or the manual, even if the publisher has expressly indicated the potential for occurrence of such damage. The publisher assumes no liability for any product defects. This warranty and liability limitation applies to all distributors and sales partners as well.

Trademarks

The trademarks mentioned in this manual are generally noted as such and are the property of their owners. Lack of such designation does not imply, however, that names are not protected by trademark laws.

© Fluke Corporation, all rights reserved

Foreword

Congratulations! And thank you for selecting the VIBXPERT EX FFT data collector and signal analyzer*. This newly developed measurement device is not just the ideal companion for your routine measurement round, but also a reliable on-site aid for recording and analyzing complex machine signals.

* Also referred to as 'VIBXPERT EX' and 'device' in these operating instructions.

VIBXPERT EX records all types of machine vibrations, bearing conditions as well as process and visual inspection data, and transfers this information to the OMNITREND maintenance software for evaluation, archiving and documentation.

The combination of its extensive range of features and easy operation makes VIBXPERT EX the effective choice for a wide range of applications:

- High measurement accuracy and high-speed data collection
- Operating modes:
 - 'Route' for routine data collection for condition-based maintenance,
 - 'Multimode' for individual measurements for machine diagnosis
 - 'Balancing' in one or two planes (optional).
 - 'Machine templates' for recurrent measurement tasks within the scope of acceptance or service measurements
- Almost every type of sensor can be connected
- One or two measurement channels (analog);
 - Upgrade to 2-channel device at any time via password.
- Intrinsic safety approved for zone 1

Hardware

- Two synchronous measurement channels for diagnosis of complex measurements (e.g. shaft vibration).
- Unlimited storage capacity (Standard: 2 GB CompactFlash).
- Three alarm LEDs (red-yellow-green) indicate if thresholds have been exceeded (based on ISO standards). A blue LED lights up if everything is OK.
- Daylight sensor controls keyboard illumination
- Dustproof and splashproof (IP65) - ideal for use in demanding industrial environments
- Connector technology compatible to VIBSCANNER (same cable)
- Connector for NiCrNi thermocouples
- Connector for headphones

Data collection and data analysis

- Overall values
 - Vibration acceleration, velocity, displacement
 - Current & voltage (process parameters)
 - Shock pulse (bearing condition)
 - Temperature
 - RPM
- Signals
 - Frequency-based and order-based data collection
 - Amplitude, envelope, order spectra

- Cepstrum
- Time waveform
- Phase measurement (synchronous, cross channel)
- Dynamic shaft movement (Orbit and shaft displacement)

Structural analysis:

- Coast down / Run up analysis (natural frequencies, machine)
- Impact test (natural frequencies, machine components)
- Advanced measurements
 - 1+1 dual measurement (simultaneous 2-channel measurement)
 - Multitask (measure multiple measurement tasks in a sequence)
 - On-site balancing in one or two planes
 - TrendingSpectrum (a measurement provides a time signal, a spectrum and several characteristic overall values, in route and template mode).
 - Recording

Ergonomics

- Large, backlit screen (480 x 320 pixels, 115 x 78 mm 16 gray levels) ensures clear data presentation and optimum readability
- Easy-to-use joystick operation
- Graphical user interface
- Color-coded connectors
- Online, context-sensitive HELP

Power supply

- Lithium-Ion battery of latest generation for more than 8 hours of operation
- Smart battery charging in VIBXPERT EX or in external charging station.
- Automatic power management (display illumination, device)

Communication

- Fully networkable
- PC connection via USB, Ethernet, RS232.

Documentation

- Printing out of reports, directly on paper or as a PDF file.

VIBXPERT EX from PRÜFTECHNIK once again demonstrates the company's skills and innovative strength in the field of maintenance, and is a consistent advancement in the series of successful portable device systems such as VIBSCANNER, VIBROCORD, VIBROTIP, VIBCODE.

Also, we would like to make you aware of the application-oriented seminars offered by PRÜFTECHNIK that feature a significant practical segment. They are very well received by course participants and you will find them to be a good investment.

Check with PRÜFTECHNIK or with your local distributor for availability and schedules. For further information, visit our website:

<http://www.pruftechnik.com>

Contents

Chapter 1: Prior to starting	9
Safety and operating notes.....	10
Nameplate.....	14
Chapter 2: Getting started	15
Overview.....	15
Operating and display elements.....	16
Keyboard.....	16
LED status indicators.....	16
Display	17
Shoulder strap.....	17
Interfaces	18
Charging socket	19
Power supply.....	20
Notes on operation	21
Basic settings - Device Setup	22
Date & Time	22
Display settings, switchoff and additional options	23
Route	24
Transducers	29
Language	33
Registration	33
Units	34
Key controls	35
Printer	36
Analog out/headphones	38
Service menu.....	39
Memory card (CF).....	41
Standardization factor for dB scaling.....	41
Deleting files	41
Data transfer.....	42
Network connection	43
Setting up the network communication	44
IP address of the local PC in the network	45
Entering a fix IP address for the local PC	45
Update.....	46
Chapter 3: Measurement	49
Preparation	49
What is a measurement task?.....	50
Multimode: Measurement, Analysis, Diagnosis	51
Typical workflow of a measurement.....	51
Starting a measurement:.....	51
Continuous measurement (live mode).....	52
Save result.....	52
Measurement of a route.....	53
Preliminary remarks	53
Notes about routes.....	55
Typical workflow of a route.....	55
Start Route.....	55
Icons	57
MENU functions in the tree / list view	58
MENU functions in the measurement task selection screen	60

Measuring with a machine template.....	61
Preliminary remarks	62
Start measurement	63
Options before, during and after a measurement	65
Aborting a measurement	65
Repeating a measurement	65
Saving a result	65
Changing the measurement channel	65
Changing the sensor	66
Entering the RPM manually.....	66
Changing the measurement task (M).....	67
Setting up a new measurement task (M).....	67
Creating a new setup (M)	68
Entering an Event/Comment.....	74
Signal sensitivity on analog output/headphones.....	75
Trend.....	76
Near location (Route).....	80
Recording.....	82
Time waveform recorder	86
Chapter 4: Results	87
Evaluating results	88
Result details	88
Characteristic overall value - single values	88
Characteristic overall values - trending.....	89
Time waveform	90
Spectrum, Cepstrum.....	94
3D display of spectra: Waterfall diagram.....	99
Configuring the result display (Display Setup)	101
Printing out reports	105
Preparations	105
Printing the screen content of a measurement	105
Measurement reports	105
Configuring the measurement report.....	106
Printing out the measurement report	107
Printing out the report for route/machine template.....	108
Chapter 5: Measurement tasks	109
Characteristic overall vibration values.....	109
Shock pulse measurement	110
RPM measurements.....	112
Temperature measurement	113
Runup / Coastdown.....	114
Shaft centerline plot	120
Phase measurement	122
Orbit	124
Envelope analysis.....	126
Cepstrum analysis.....	127
User-defined measurement variables.....	127
Multi-measurement task ('Multitask').....	128
Dual measurement (1+1)	131
Impact test - 1 channel.....	133
Modal analysis - two-channel impact test	135
TrendingSpectrum	137
Order spectrum	137
Order-based spectrum	137
DC measurements	138

Chapter 6: Appendix.....	139
Numerical editor.....	139
Text Editor.....	140
File Manager.....	141
Functions of the MENU key.....	141
Printing out the PDF file.....	142
VIBXPERT utility.....	143
Installing and starting the program.....	143
Registering optional functions.....	144
Setting up a connection with VIBXPERT EX.....	145
Configuring VIBXPERT EX.....	145
Transferring files.....	146
Transferring system files.....	147
VIBCODE.....	148
Mechanical coding.....	148
Coding.....	149
VIBCODE concept.....	149
Measuring with VIBCODE.....	150
Measuring VIBCODE Route/ Pool.....	151
Technical notes.....	152
Storage.....	152
Cleaning.....	152
Maintenance & Calibration.....	152
Guarantee.....	152
Spare parts, accessories.....	153
Disposal.....	153
Technical data.....	154
Troubleshooting.....	156
Reloading firmware.....	156
Index.....	158

Chapter 1: Prior to starting

On delivery, check the goods for damaged or missing parts. Note any possibly objectionable parts on the shipping documents and claim them with the forwarder or your local PRUFTECHNIK partner.

Service addresses

Feel free to contact us in case of questions:

Hotline: +49 89 99616-0

E-mail: info@pruftechnik.com

Service address:

Fluke Deutschland GmbH
Freisinger Str. 34,
85737 Ismaning, Germany

About this manual

This manual describes the basic functions and operation of the measurement device in the 'Multimode', 'Templates' and 'Route' operating modes. The operation of the optional 'Balancing' module is described in the 'VIBXPERT EX - Balancing' operating manual (VIB 9.806.G).

If you don't have this manual handy, open the online help in the device with the HELP key.

This manual is valid for Firmware Version 2.3x.



Safety and operating notes

Read this section carefully, paying especially close attention to the safety notes, before working with the device.

Symbols used**Attention!**

This symbol warns of operating errors that can lead to data loss or equipment damage.

**Note**

This symbol denotes information and tips on operating the data collector.

Intended use

- The measurement device may only be used for the measurement of machine signals in industrial environments while taking into consideration the technical specifications (see "Technical data").
- Transducers and cables may be used only for their respective intended uses as defined in the corresponding sales leaflets.

Any other use shall not be considered an intended use and is impermissible. Incorrect or impermissible use and failure to observe the instructions in this manual result in a loss of warranty from PRÜFTECHNIK.

Conformity

The product complies with the relevant European directives. The declaration of conformity is available as a PDF and may be downloaded from the PRÜFTECHNIK homepage at:

www.pruftechnik.com/com/Know-How/Media-Center/Certificates-and-Material-Safety



General safety

The following notes must be carefully read and completely understood before the device is put into service.

- ◆ Risk of injury when measuring on a running machine!
Observe the safety regulations. Install the measurement equipment properly. During measurement on machines with rotating parts exposed, ensure that no brackets, cables etc. can become caught in rotating machine parts.
- ◆ The measurement device may only be operated if it is undamaged, dry and clean.
- ◆ Operation and maintenance are to be performed only by properly trained personnel.
- ◆ Repairs to the device may be carried out only by a PRÜFTECHNIK-authorized service technician.
- ◆ Only original spare parts and accessories may be used.
- ◆ Only properly functioning, regularly-maintained electrical equipment may be used. Any defects such as broken plugs or loose sockets must be corrected immediately. Damaged cables must be replaced by an authorized service technician.
- ◆ Any alterations that affect device design or operating safety are not permitted.
- ◆ The installation and operation of the device must be in accordance with the regulations in the European Installation Rules (EN 60079-10, latest revision), the equipment safety law as well as the generally recognized codes of practice. The instructions in this manual must also be observed.
- ◆ The most current regulations regarding servicing, maintenance and testing, as they appear in EN 60079-14 and EN 60079-17, must be observed. The rules of the manufacturer, as they appear in this manual, and the EC-type Examination Certificate (ZELM 07 ATEX 355X) must also be observed. These documents can be downloaded from the PRUFTECHNIK website.

Environmental influences

- ◆ Portable radio-based devices can interfere with proper functioning of the device when operated nearby. In case of doubt, check the connecting cable between the device and its transducer.
- ◆ Avoid exposing the device, its transducers and cables to environmental conditions that exceed the tolerances listed in the 'Technical Data' section at the rear of this manual.
- ◆ Keep the protective caps on the connector sockets when they are not in use to keep them clean.

How to deal with rechargeable batteries

- ◆ Charge the battery only outside the EX area.
- ◆ Do not send devices with defective battery by air freight.
- ◆ Defective batteries may only be replaced by authorized PRÜFTECHNIK personnel.

Specific provisions for operation in EX areas:

- ◆ When equipment to be measured is located in an EX area, the intrinsically safe VIBXPERT EX and the appropriate intrinsically safe sensors and accessories must be used.
- ◆ For vibration measurements, you may only connect LineDrive transducers of the VIB 6.1xx DEX model series or VIBCODE transducers (VIB 8.660 HEX) to the measurement device.
- ◆ Under no circumstances may you take measurements with the following sensors: TIPTECTOR hand-held probe, LineDrive transducers of the VIB 6.1xx EX, VIB 6.1xx REX model series.
- ◆ Under no circumstances should you use the connection cable for extra-low signal currents (VIB 5.434) and extra-low signal voltages (VIB 5.433).
- ◆ Under no circumstances should you use the VIBXPERT EX case (VIB 5.329 X).
- ◆ The device may only be connected outside the hazardous area to a computer*. Use only the adapter VIB 5.330-UNV.
- ◆ The protective film must be removed from the display.

* The computer meets the requirements of the Equipment Safety Act.

Interface parameters for VIBXPERT EX

Analog output circuit

In type of protection intrinsic safety Ex ib IIC, only suitable for the connection to devices intended for this

$$\begin{array}{lll} U_o = 28V & I_o = 63mA & P_o = 300mW \\ C_i = 54nF & C_o = 83nF & \\ L_i = 300\mu H & L_o = 7mH & \end{array}$$

The sensors of the VIB 6.1***DEX model series can also be connected to this interface. The sensors of the VIB 6.1***EX model series should not be connected to this interface.

Temperature sensor circuit

In type of protection intrinsic safety Ex ib IIC, only suitable for the connection to NiCr-Ni-thermocouple

$$\begin{array}{lll} U_o = 6V & I_o = 6mA & P_o = 8mW \\ C_o = 40\mu F & L_o = 0,8H & \end{array}$$

Digital output circuit

in type of protection intrinsic safety Ex ib IIC only suitable for the connection to devices intended for this

$$\begin{array}{lll} U_o = 12V & I_o = 188mA & P_o = 600mW \\ C_o = 1,41\mu F & L_o = 0,8mH & \end{array}$$

LAN/USB circuit

Do not use this interface in an explosive environment! Only devices with $V_m < 6V$ or the communication adapter for VIBXPERT EX (order no. VIB 5.330 UNV) may be connected for data transmission purposes.

Battery load circuit

Do not use this interface in an explosive environment!
To charge the batteries, use charger VIB 5.322-INT only!

Nameplate

The diagram below shows the location and the contents of the device nameplate.

Nameplate for the VIBXPERT EX device with serial number ('S.No.') and safety notes.

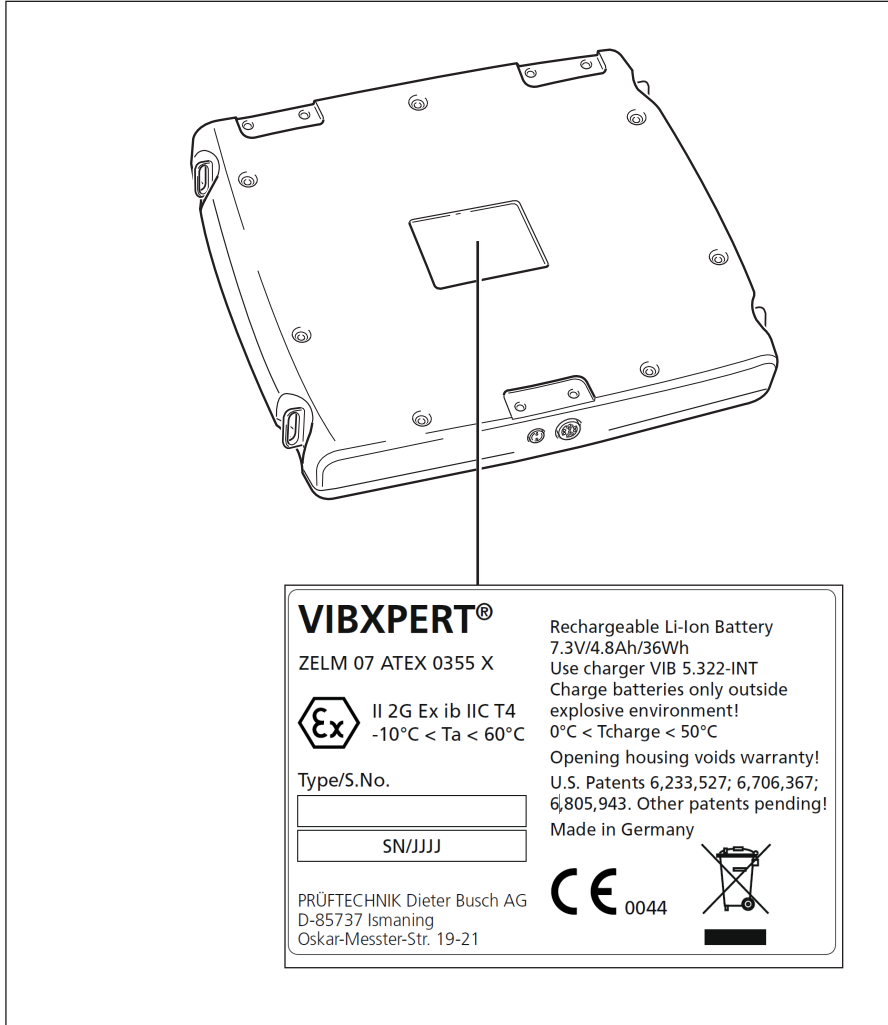

Chapter 2: Getting started

Overview

The illustrations show the interfaces and operating elements of the measurement device:

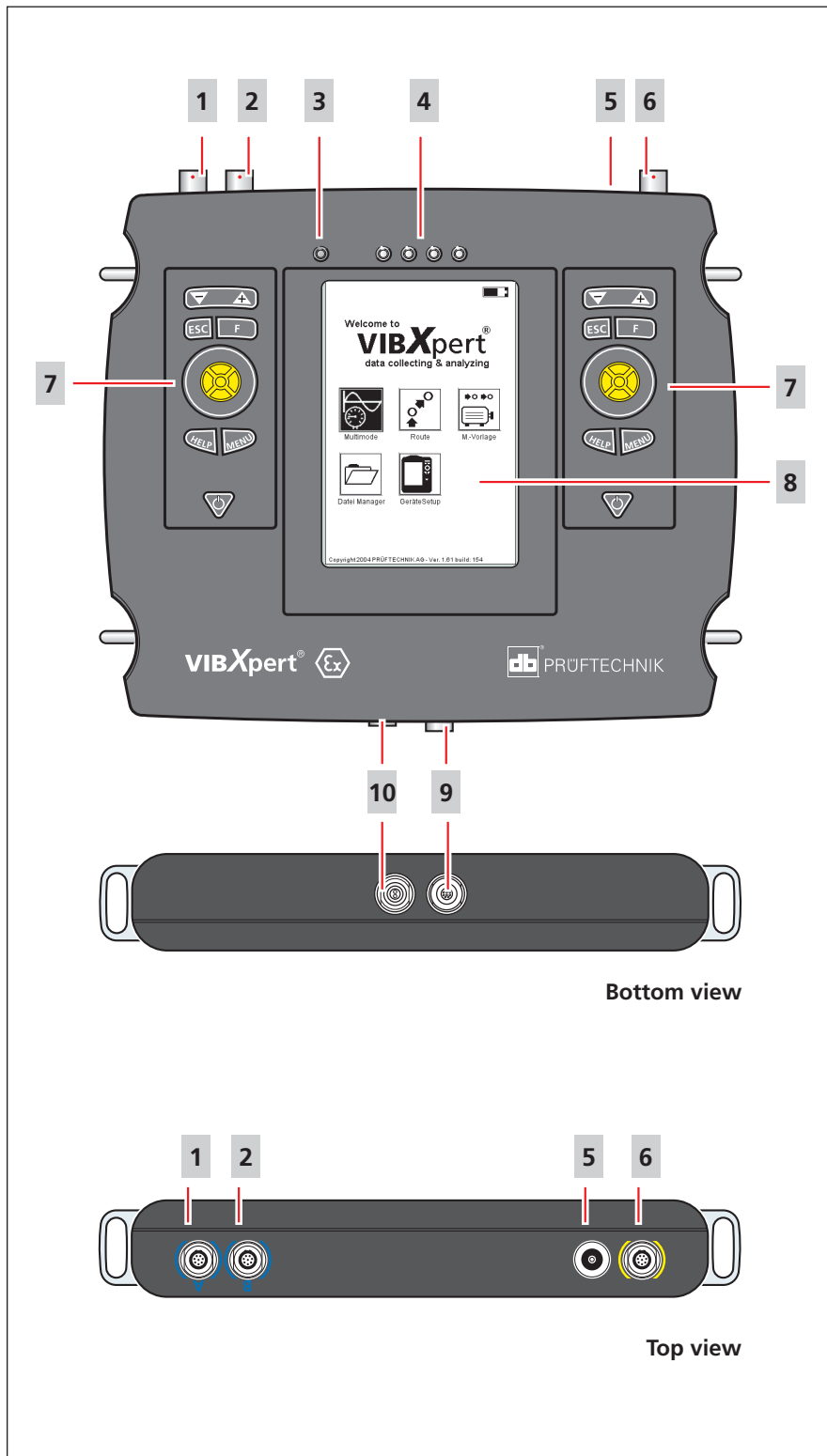

Interfaces, operating and display elements

1	Measurement channel A, analog
2	Measurement channel B, analog
3	Light sensor controls keyboard illumination
4	Status LEDs indicate threshold violation, measurement error, battery status
5	Temperature channel, connects thermocouple (type K)
6	Digital port, connects trigger / RPM sensor, RS232, Signal-OUT
7	Keyboard and joystick, provides left- & right-hand operation
8	Display
9	Communication port connects Ethernet and USB
10	Charger socket

Operating and display elements

Keyboard

The keys and the joystick are ergonomically arranged on the left and right sides so that VIBXPERT EX can be comfortably operated with the thumb. The keyboard automatically illuminates in dark surroundings.

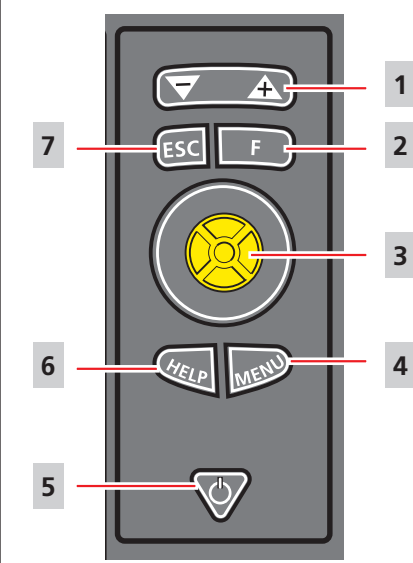

Keyboard	
1	Rocker key '+/-' , zoom for X axis, change tab
2	F key , special functions such as tab, fast key, search.
3	Joystick , navigation and ENTER key
4	MENU key , opens menu
5	ON/OFF key , switch device on/off or reset device .
6	HELP key , shows context sensitive help page
7	ESC key , Cancel, Return or Switch off device (in start screen only).

LED status indicators

Four colored LEDs indicate threshold violations, errors, and system status and show the battery status while charging in the device.

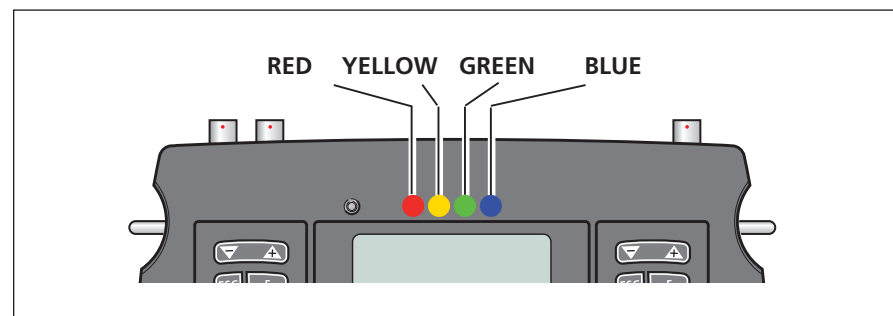

Status and alarm indication				
	RED	YELLOW	GREEN	BLUE
LED constant	Alarm	Warning	Prewarning	OK
LED flashing	Signal overload / Battery empty	Signal unlabel	Trigger signal	Batt. almost empty
Note: Flashing LEDs have the higher priority, i.e RED flashes with signal overload and alarm level exceeded.				

Battery status during charging				
	RED	YELLOW	GREEN	BLUE
LED constant	Error	Battery charging	Battery full	---

Display

In the device settings menu you can change the following display settings if required: Brightness, Contrast, switch-off interval of the display illumination. Upon delivery, a protective foil is applied to the display, which must be removed before initial startup.

Shoulder strap

Fasten the strap to the two diagonally opposite eyelets. Adjust the strap length so that the device hangs comfortably from the shoulder to allow convenient operation.



Interfaces

The connections for the sensor and data cables are located on the front of the measurement device.

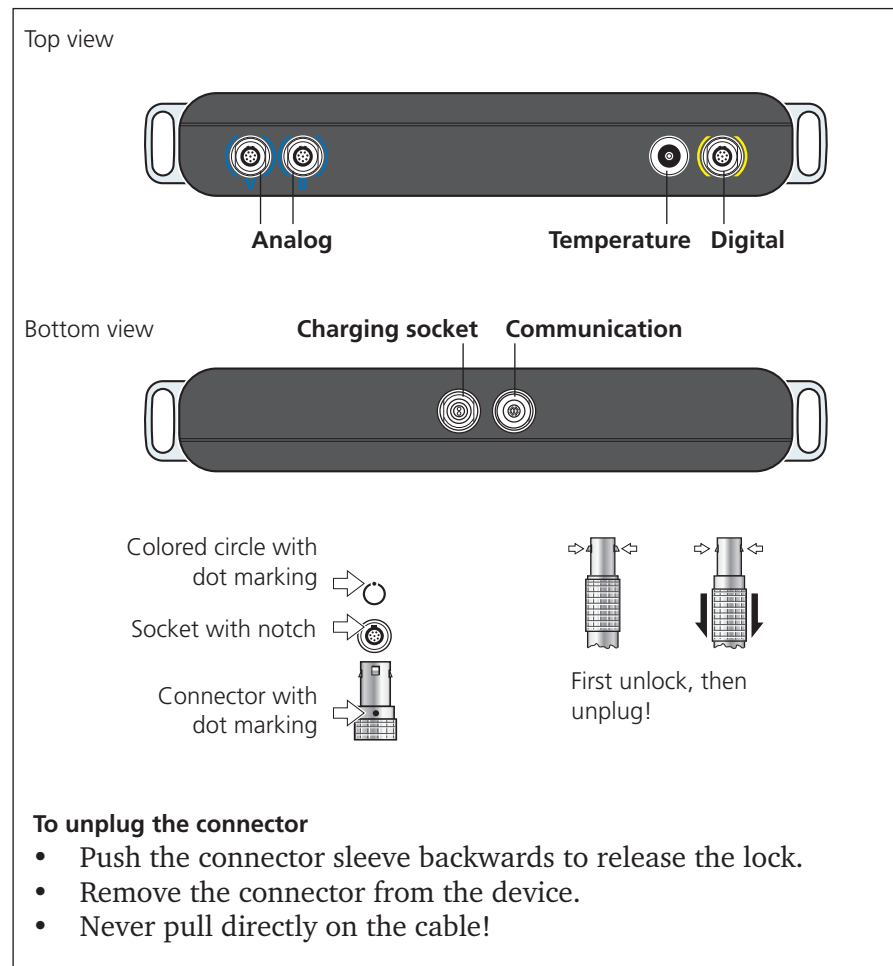

Analog

The blue channels marked with 'A' and 'B' are used as the input for analog signals.



The analog measurement channels are not electrically insulated. For 2-channel measurement on two machines, check the potential equalization (VDE 0100) or use electrically insulated sensors.

Digital

The yellow channel is used as the:

- Input for the digital signal (trigger or rpm sensor)
- Serial interface for data transmission (RS 232)

Power supply

VIBXPERT EX is supplied with energy by a Lithium-Ion rechargeable battery which is permanently installed in the housing and may only be replaced by authorized PRÜFTECHNIK employees.

The residual charge of the battery is displayed above the battery icon on the upper right of the display. If the battery is almost empty, a message appears on the display and the blue LED flashes. This continues for a few minutes to enable any measurements that are running to be completed and the battery to be replaced or recharged.

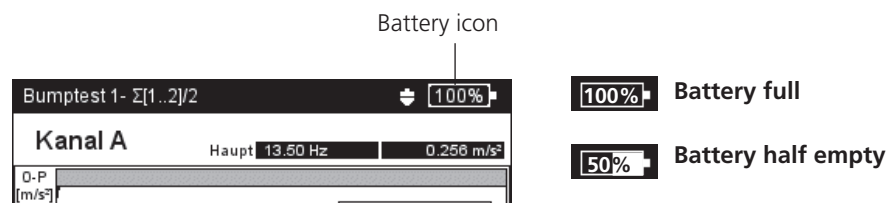

- Follow the safety instructions enclosed with the charger.
- Do not send devices with defective batteries by air freight.
- Defective batteries may only be replaced by authorized PRÜFTECHNIK personnel.
- During extended periods of non-use and during storage, connect VIBXPERT EX regularly to the mains supply. This prevents the battery from becoming completely discharged, and the date and time settings are retained.

Notes on operation

To keep operation as simple and intuitive as possible, the graphical user interface is based on the 'Microsoft Windows' operating concept.

Switch on / off

To switch on the device, hold the On/Off key down for two seconds. VIBXPERT EX is ready for operation when the start screen appears. To switch off, press the On/Off key again for 2 seconds and confirm the resulting query to switch off with 'YES'.

Reset:

Press the On/Off key for approx. 5 seconds until the device switches off and restarts.

Navigation and editing

Select the screen elements with the cursor which can be moved by the joystick. The selected element is highlighted. To confirm the selection, press the joystick (= 'click').

Some examples of navigation and editing are shown below:

Fields

lack frame => 'Measurement channel' field is selected.

Grey frame => Selection confirmed. The settings can now be modified ('Channel A' or 'Channel B').



Menu

The functions of the current program section are found in the 'Menu' which is displayed with the MENU key and hidden again with the ESC key.

An arrow next to a menu entry indicates a further submenu. To open it, move the joystick to the right.

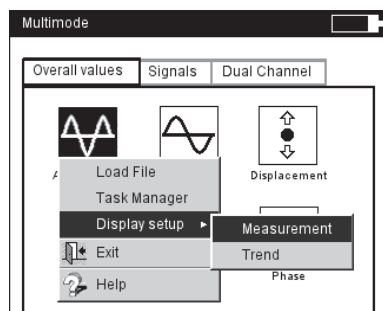

Help

Tips and operating instructions are available for almost every screen in the program. Call up these help pages at any time by pressing the HELP key and close them by pressing the HELP key again.

Switching on VIBXPERT EX



Basic settings - Device Setup

Before carrying out measurements with VIBXPRT EX, the basic settings in the 'Device Setup' should be checked and changed if necessary.



Device Setup



Device Setup



Date & Time

- Switch on VIBXPRT EX.
- Click on 'Device Setup' in the start screen. The 'Device Setup' screen appears.

Date & Time

The time and date are saved together with the measurement result.

To change the settings:

- Click on 'Date & Time'.
- Click in the 'Time' window and select the numerals for the hours, minutes or seconds.
- To change the numeric value, move the joystick up or down - without clicking!
- When finished click the joystick to leave the 'Time' window.
- Select the 'Time format':
HH:mm:ss = 24 h / hh:mm:ssAP = 12 h
- The date is set in the same way. Select the appropriate 'Date format'.

Other parameters

Time zone: Time shift to GMT (Greenwich Mean Time)
Daylight saving: Yes = + 1h

- To accept the changes, press MENU and click on 'OK'.

Left:
Basic settings in the Device Setup

Right:
Time and Date

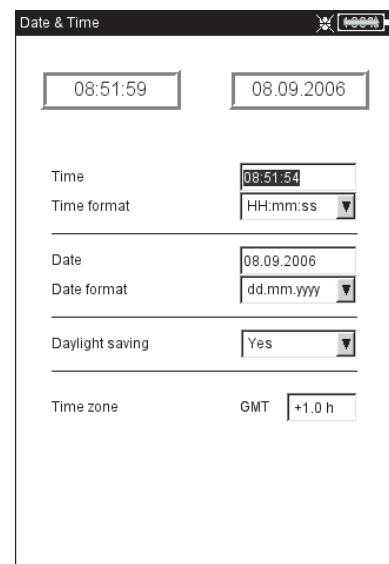
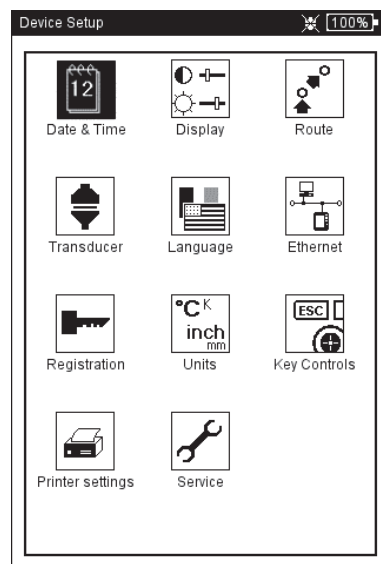

Display settings, switchoff and additional options

- Click on 'Display' in the 'Device Setup' screen.

CONTRAST AND BRIGHTNESS: Click on the respective field and move the joystick to the right or left. To accept the setting, press the joystick.

SWITCH BACKLIGHT OFF / AUTO POWER OFF: The display illumination / the device automatically switches off if no action occurs within the turn-off time (illumination: 10s ... 1m / device: 6m ... 6h). The automatic switch off is disabled in the measurement screen / results screen.

BACKGROUND IMAGE: A background image (PNG format) can be displayed in the start screen. Four standard images are stored on the device. Additional images can be loaded onto the device using the 'VIBXPRT utility' tool.

SHOW BATTERY CHARGE: Display the remaining battery charge in percent.

SPECTRUM: SHOW LINES BELOW LOWER FREQUENCY (f_{\min}): In spectra with a lower limit frequency of $f_{\min} > 0$ Hz, the lines between 0 Hz and f_{\min} are displayed in the diagram if this option is enabled.

HIDE CALIBRATION HINT: The message for overdue calibration is not shown.

- To accept the settings, press MENU and click on 'OK'.



Device Setup



Display

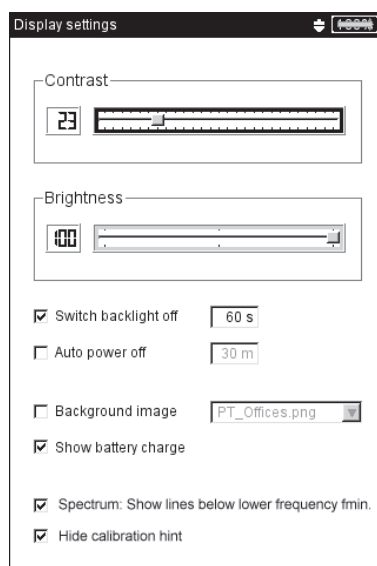

Display settings

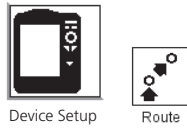

Route

- Click on 'Route' in the 'Device Setup'.

The settings in the Route Setup apply to measurements in the 'Route' / 'Template' mode. The Route Setup can be called up and adjusted at any time in the route/template. For clarity, the numerous settings in the Route Setup are grouped into three submenus (see below):

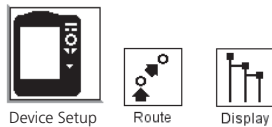
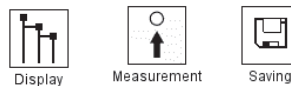

Route display settings

- Click on 'Display' to set up the following options:

Route display type

The route/machine template can be displayed in the hierarchical tree view or as a list.

- TREE: In this view, the measurement locations and the higher-level hierarchies are displayed as a tree structure, as they are in OMNI-TREND. The measurement locations are processed in the defined order.
- LIST: The list view shows the measurement locations in the order in which they are processed.



Note

If the machine templates were created in the 'Production test' mode, a list view is not possible.

Graphic Route

Graphic user guidance using machine graphics that indicate the position of the measurement locations and the measurement direction. This display mode is only possible when the route is displayed in the tree view.

Left:
Basic settings for the route/
template operating mode

Right:
Setting up the display

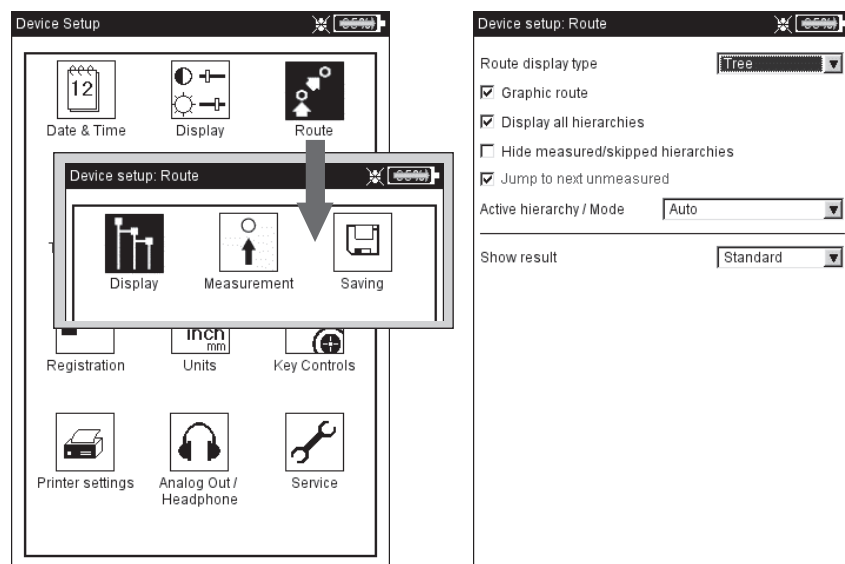

- **ENABLED:** Display of machine images. The position of the measurement locations and the measurement direction is indicated by symbols.
- **DISABLED:** The route is processed in the set display mode (tree / list)

Display all hierarchies

This option applies to the tree view only.

- **ENABLED:** The tree displays all hierarchy levels.
- **DISABLED:** The tree only opens the branch with the first non-measured measurement location.

Hide measured/ skipped hierarchies

This option applies to the tree view only.

- **ENABLED:** Measured/skipped hierarchy levels are hidden in the tree.
- **DISABLED:** Measured/skipped hierarchy levels are displayed in the tree.

Jump to next unmeasured (measurement location)

Here you can define to which measurement location the cursor should jump after you view a stored result and close the measurement task selection window.

- **ACTIVATED:** the cursor jumps to the next unmeasured measurement location.
- **DISABLED:** the cursor remains on the current measurement location.

Active Hierarchy/ Mode

The following settings determine how the tree structure should appear when opening the route / machine template:

- **TRAIN / MACHINE / MEASUREMENT LOCATION:** The tree opens to the selected hierarchy level*.
- **AUTO:** Dynamic adaptation of the tree view. The type of display depends on whether the route contains graphical information and whether the 'Graphic Route' option is enabled.

*The route is set up hierarchically according to the following plan:

1. Database - highest hierarchy
2. Location - factory, plant, customer
3. Train - groups of machines
4. Machine - individual machines
5. Measurement location - position of the measurement location
6. Measurement task - e.g. vibration acceleration

Show result

With every measurement task, older, historic measurements can be saved in the route and called up to compare them with current results.

- **STANDARD:** last measurement saved.
- **HISTORY:** last measurement saved and historical data.

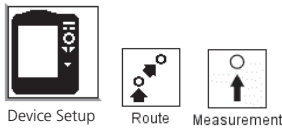

Measurement settings

- Click on 'Measurement' to set up the following options:

Auto start measurement

This shortens the duration of the entire measurement.

- **ENABLED:** Clicking the measurement location starts the first measurement automatically. If multiple measurement tasks are defined for the same accelerometer at a single measurement location, these measurement tasks are automatically run consecutively, provided that the 'Auto Save' option is enabled (see next section).
- **DISABLED:** The first measurement at a measurement location must be started manually.

Route optimizer

This function optimizes the processing of the route and shortens the time involved in collecting the measurement data.

- **ENABLED:** Measurement tasks for a measurement location with the same sensor are processed one after the other.
- **DISABLED:** Measurement tasks are processed in the sequence in which they were created in OMNITREND.

Optimize meas. time for MultiTask

The individual measurements are performed with a sensor but are processed in parallel on 2 channels in VIBXPRT EX.

- **ENABLED:** Measurements are internally distributed to both measurement channels and are processed in parallel.
- **DISABLED:** Measurements are performed in sequence on one channel.

Left:
Basic settings for the route/
template operating mode

Right:
Setting up the measurement

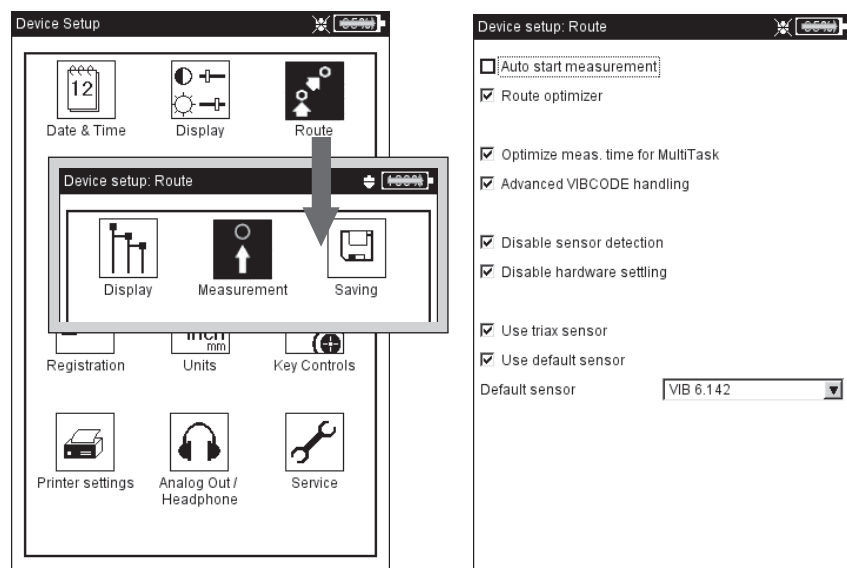

Advanced VIBCODE handling

When measurement tasks performed at a VIBCODE measurement location are not only taken by the VIBCODE sensor but by another vibration sensor, VIBXPert EX recognizes these and assigns them to another measurement channel.

- **ENABLED:** Measurement tasks with the VIBCODE sensor are performed on the VIBCODE sensor channel. The other measurements are taken on the other channel.
- **DISABLED:** The measurement tasks are measured on one channel, each with the sensor that has been set up.

Disable sensor detection

This shortens the duration of the entire measurement.

- **ENABLED:** Sensor detection is deactivated. The sensor symbol is crossed out. If several measurements are taken of a single measurement location, VIBXPert EX only performs the sensor detection and cable test before the first measurement.
- **DISABLED:** Sensor detection is active. Prior to every measurement, VIBXPert EX checks whether the correct sensor is connected and if the cable is OK. A sensor icon appears at the upper edge of the screen next to the battery icon.

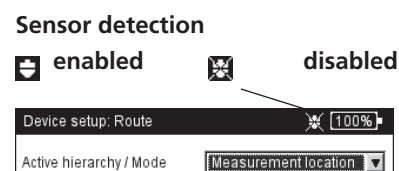

When measurements are taken with the VIBCODE sensor, sensor detection is always active!



Note

Disable hardware settling

This shortens the duration of the entire measurement.

- **ENABLED:** Amplifiers to not settled before measurement starts.
- **DISABLED:** Amplifier stages settle before measurement starts.

Measurement error may occur if the amplifier stages do not settle first!

When sensor detection is active (see above), the amplifiers always settle. The settings in this field are ignored.



Note

Triax sensor

This option is not functional in VIBXPert EX.

Standard vibration sensor

Here you define the sensor to be used for all vibration measurements on a route. The settings in OMNITREND are ignored. The 'Triax sensor' option is disabled.

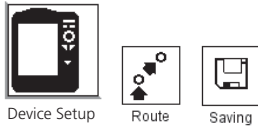

Save settings

- Click on 'Saving' to set up the following options:

AutoSave

This shortens the duration of the entire measurement.

- **ENABLED:** The selected time (0 ... 10s) corresponds to the waiting time until the result is automatically saved.
- **DISABLED:** The result must be manually saved.

Stop AutoSave on...

- **ALARM, WARNING, PREWARNING:** When the limit value is exceeded, the AutoSave mode is deactivated.
- **NEVER:** The result is always stored automatically.

To accept the settings in the 'Route Setup' and to close the menu, press MENU and click on 'OK'.

Left:
Basic settings for the route/
template operating mode

Right:
Options for saving

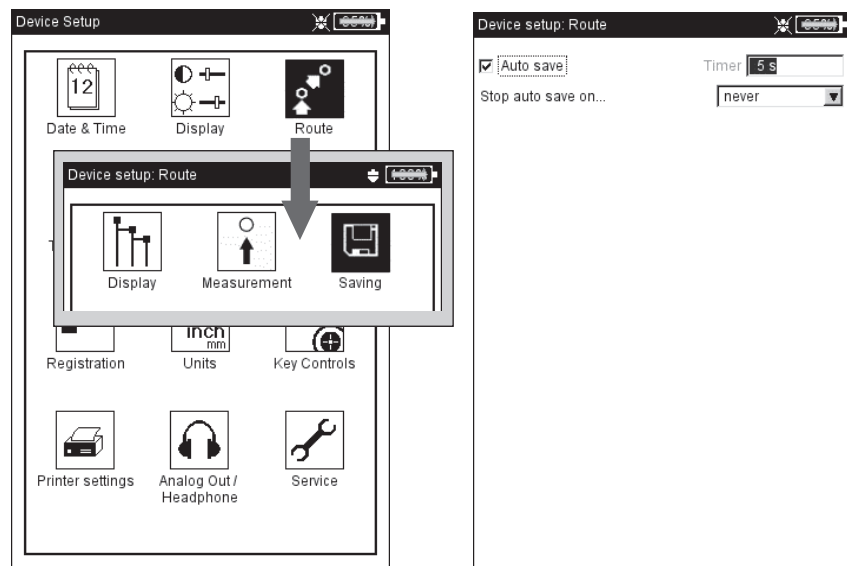

Transducers

The transducer menu (see below) contains all of the functions and presets for the transducer. Click on 'Transducers' to open the menu.

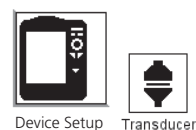

Available transducers in VIBXPERT EX

The measurement-relevant parameters for many transducers are stored in VIBXPERT EX. Consequently, when putting together a measurement task, it is only necessary to select the transducer required for the measurement.

The transducer list (see below) in the 'Available transducer' menu contains all the factory-configured and user-defined transducers. Under certain circumstances, this list can be very extensive.

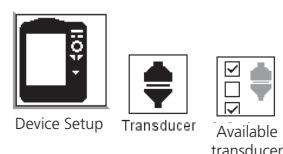

Preselecting available transducers

As it is probable that not all the transducers stored in VIBXPERT EX will be used, the choice can be restricted to those transducers that are available to the user. When setting up the measurement tasks, VIBXPERT EX only offers the choice of the preselected transducers as standard:

- Click on each of the relevant transducers in the list so that these are marked with a cross.

Displaying the transducer application

To check in which measurement task(s) the individual transducers are used, proceed as follows:

- Mark the relevant transducer in the list.
- Press the MENU key.
- Click on 'Usage' (see below).

A list appears to show the measurement tasks that are measured with the transducer.

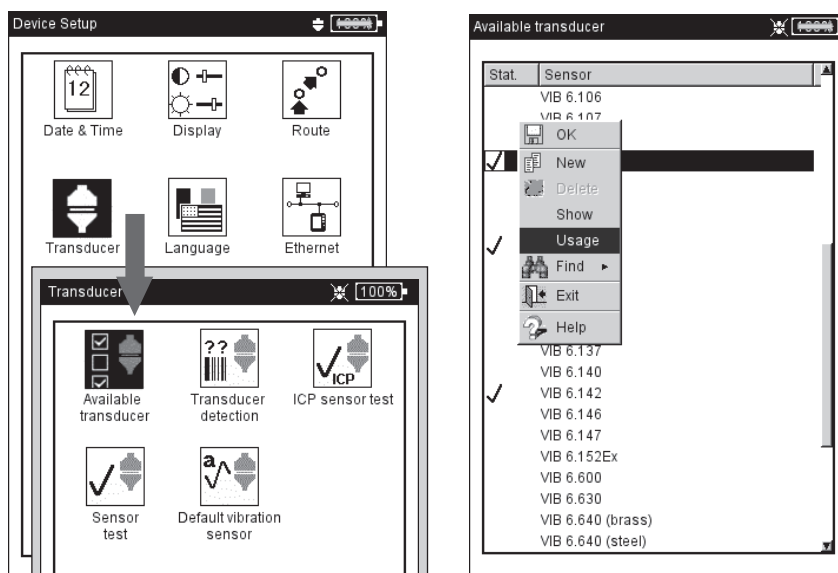

Left:
Transducer menu

Right:
Available transducers
are marked with ✓

Getting started - Basic settings

Transducer parameters

To check the parameters for transducers that have already been set up, proceed as follows:

- Select the transducer.
- Press the MENU key.
- Click on 'Show'* or 'Edit' to open the parameter screen (see below).

*'Show' appears for factory-defined transducers whose parameters cannot be changed.

MEAS. QUANTITY

Measurement quantity of the sensor: vibration acceleration, velocity, displacement, current, RPM, jump, user-defined quantity

SIGNAL TYPE

Signal type of the sensor (e.g. LineDrive, ICP, voltage)

INPUT VOLTAGE RANGE

$\pm 3V / \pm 8V^1 / \pm 30V^2$; only applies for transducers of 'Voltage' and 'VIBREX/VIBRONET' signal types.

¹ only for VIBREX / VIBRONET

² only for 'Voltage' signal type

QUANTITY (USER DEF.)

Identification for a user-defined measurement variable.

UNIT (USER. DEF.)

Unit for the user-defined variable.

PRECISION

Accuracy in decimal places.

COEFFICIENT A4, A3, A2

Parameters for linearizing a sensor's non-linear characteristic line (e.g. MNS12 proximity probe - VIB 6.640).

SENSITIVITY

The sensitivity of the sensor determines the signal level.

OFFSET

Offset of the sensor

LINEAR FROM / TO

The linearity range of the sensor and the filter setting of the measurement must be adapted to one another.

Transducer parameters
for VIB 6.140 accelerometer

Sensor Setup	
VIB 6.140	
Meas. quantity	Acceleration
Signal Type	LineDrive
Sensitivity	1.000 $\mu A/m/s^2$
Offset	0.00 μA
Linear from	1.00 Hz
Linear to	20000.00 Hz
Resonance Freq.	36000.00 Hz

RESONANCE FREQUENCY

The resonant frequency of the sensor is an important influencing quantity in the shock pulse measurement (bearing condition).

SETTLING TIME (RPM)

Settling time of the RPM sensor

Filtering the transducer list

The transducer list can be filtered according to specific criteria:

- Press the MENU key.
- Click on 'Find'.
- Move the joystick to the right to open the associated submenu.

The following criteria can be selected here:

- ALL:** Display all transducers
FACTORY: Display factory-configured transducers only
USER: Display user-configured transducers only
AVAILABLE: Display preselected transducers as 'available' only
MEAS. QUANTITY: Display the transducers for a specific measurement quantity only; the measurement quantity is selected in the associated submenu (see below).

Setting up new transducers

To set up a new transducer, proceed as follows:

- In the transducer list press the MENU key.
- Click on 'New'. The Text Editor appears.
- Enter a name for the new transducer.
- Set up the transducer parameters (see previous page).
- Finally, press the MENU key and click on 'OK' to save the new transducer.

To accept the settings, press MENU and click on 'OK'.

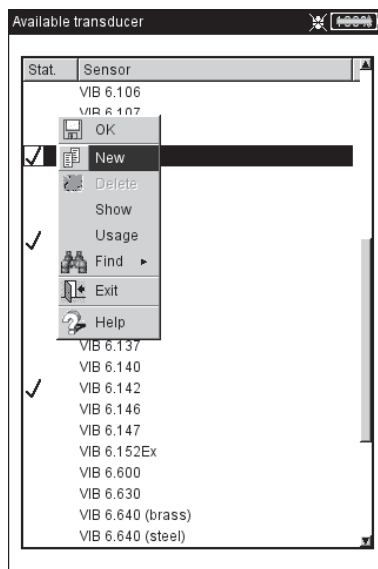
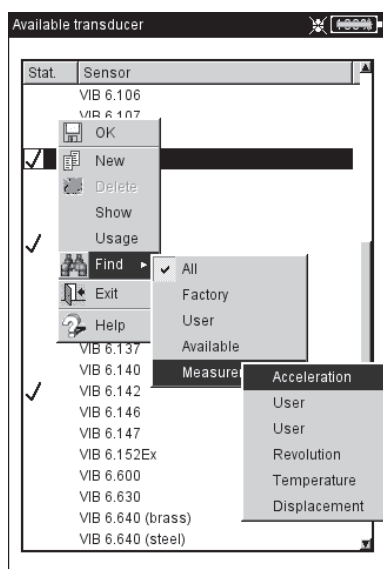

Left:

Sort transducer list:

Display transducers for the 'user-defined' meas. quantity only

Right:

Creating a new transducer

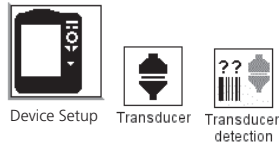
**Note****Transducer detection and Hardware setting**

In this menu, the transducer detection feature and the settling of the amplifier stages in VIBXPRT EX can be switched on and off. Additional information can be found in the 'Route Setup' section.

The settling of the amplifier stages can only be activated when the transducer detection is switched off.

The settings in this menu apply to the 'Multimode' operating mode only. The settings for the 'Route' and 'Machine template' modes are made in the 'Route Setup' menu.

After the device is switched on, the amplifiers always settle prior to the first measurement.

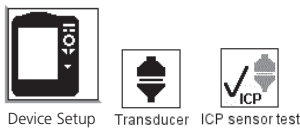
**Sensor test**

Here you can manually check the measurement path to the sensor. For ICP sensors, use the 'ICP Sensor Test' menu; for all other sensors, use the 'Sensor Test' menu.

- Select the channel to which the sensor is connected (A, B).
- Click on START.
VIBXPRT EX then checks the measurement path and displays the result ('LineDrive', 'Open line', 'Short circuit', etc.).

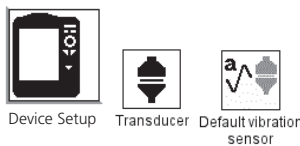
**Default vibration sensor (Multimode)**

A default sensor can be specified for all vibration measurements in the 'Multimode' mode. In the route / machine template, a default sensor can only be set up via the 'Runtime setup' menu or the Route Device Setup respectively.

- Activate the check box and select the vibration sensor.

Left:
Checking the measurement path on channel A

Right:
Default sensor for vibration measurement in 'Multimode'

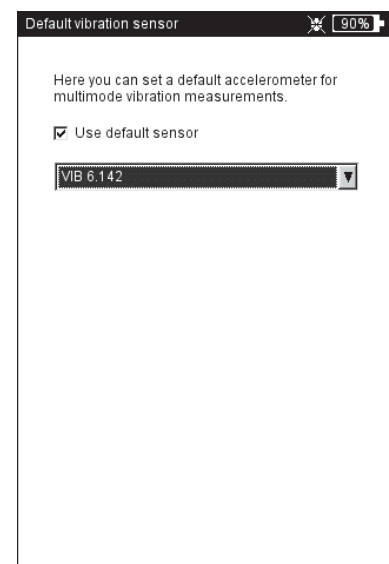
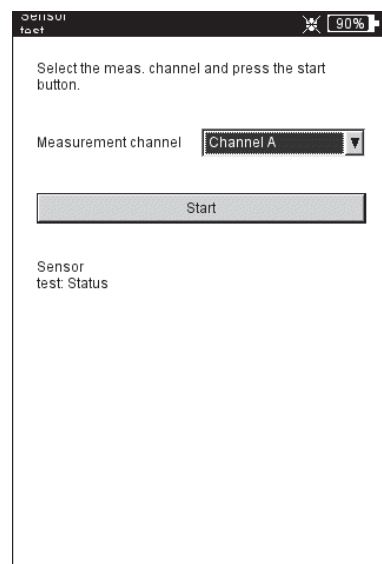

When a default sensor has been set up, the sensor can no longer be specified in the measurement task manager. The corresponding field is grayed out, although the sensor originally specified is still visible.



Note

Keyphaser

Here you can extend the time limit set for rpm measurements and phase measurement to enable measurements on very low-speed machines (range: 10 ... 30 s, default: 10s). The 'Active edge' option is used to define whether the edge of the incoming trigger mark or outgoing trigger mark on the shaft is to be used as the reference signal.



Device Setup



Transducer



Keyphaser

Language

VIBXPRT EX includes 11 languages. The default setting is 'English'. To change the language setting, proceed as follows:

- Click on 'Language'.
- Click on 'YourLanguage' (e.g. *Espanol, Francais,...*).
- Press MENU and click on 'OK'.
- Confirm the resulting message to restart the application (see below).



Device Setup



Language

Communication

Settings for network communication,.



Device Setup



Communication

Registration

The functions and operating modes in VIBXPRT EX are distributed in individual modules* that can be enabled by password as required. VIBXPRT EX is supplied in the 'Basic' version with which overall values as well as (limited) spectra can be measured.

*The appendix contains an overview of the modules and the available measurement functions.

Dialog language

is changed to 'Deutsch' (German)

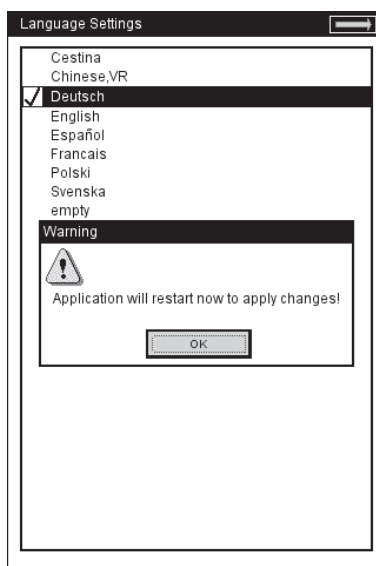

Getting started - Basic settings



For example, to enable the standard 1-channel version, the 'VIBXPERT firmware for 1 channel' module must be registered in VIBXPERT EX. The corresponding password can be found on the associated registration certificate:

- Click on 'Registration'.
- Click on the module to be registered and enter the password in the text editor.

Registered modules are marked with a cross.

VIBXPERT PC license

Before VIBXPERT EX can exchange data with OMNITREND, the device must be registered in the software. This is generally performed by entering the PC license password in OMNITREND.

Here you can enter the password in VIBXPERT EX, which is then automatically read into the software to register the device when it first makes contact with OMNITREND.

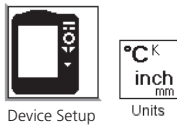

Units

The units - where appropriate - are set to SI units in the factory. To change the unit for the respective measurement quantities, proceed as follows:

- Click on 'Units'.
- Select the units for the measurement quantities.

The accuracy in decimal places appears in the lower area of the window for the current unit as well as the conversion factor for the associated SI unit. It is not yet possible to define, delete or edit units.

To accept the settings, press MENU and click on 'OK'.

Left:
Registration menu

Right:
Units menu

The VIBXPERT PC license automates the device registration process in OMNITREND.

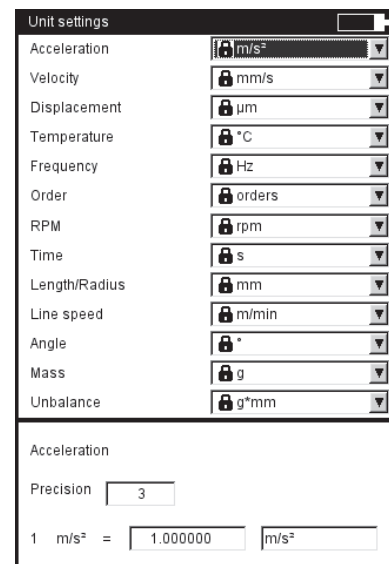
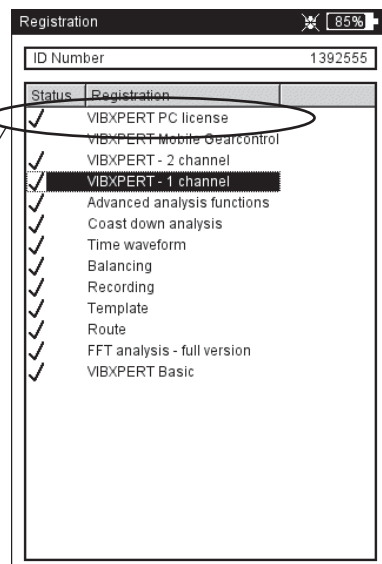

Key controls

Additional functions are activated for some keys in VIBXPERT EX as standard that are intended to ease working on-site on the machine or to increase data security.

- Click on 'Key controls'.
The following options can be activated or deactivated in the next screen:

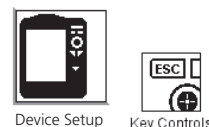

Additional key on the rear panel

This option is not functional in VIBXPERT EX.

'Save?' prompt after ESC

The 'Save?' prompt appears if you press the ESC key without having saved the changes/measurement results in the current screen beforehand. This query always appears for run-up and coast-down measurements, even if this option is disabled.

Prompt for repeat measurement

A repeat measurement is normally started by pressing the joystick in the measurement screen. A corresponding prompt prevents inadvertent triggering of a repeat measurement.

To accept the changes, press MENU and click on 'OK'.

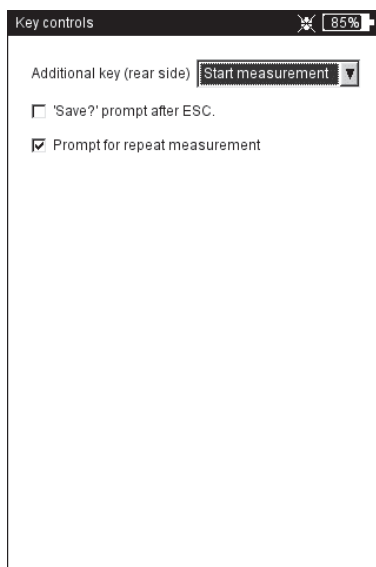

Special keyboard functions

Getting started - Basic settings

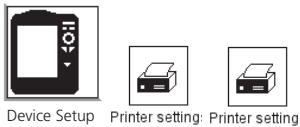
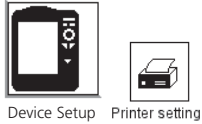

Printer

With VIBXPRT EX, you can print out measurement results, reports and PDF file directly on a USB printer.

- Click on the 'Printer settings' icon to open the Printer menu.

Setting up a printer

To set up a new printer, proceed as follows:

- Click on the 'Printer settings' icon to open the 'Printer settings' menu (see below).
- Select the top menu, press the MENU key and click on 'New' (see below).
- Select your printer type.
- Enter a name in the text editor.
- Then set the print parameters: Resolution, paper format and - depending on the printer type - the color model and paper source.
- Check the print function by printing a test page:
 - Connect VIBXPRT EX to the printer.
 - Press the MENU key and click on 'Test page'.

The test page is printed as soon as the print job has been processed by VIBXPRT EX. If you select 'PDF' as the printer, you can print the PDF file directly from the measurement device or transfer the PDF file to a PC using the 'VIBXPRT utility' tool.

Left:
Printer menu

Right:
Printer settings

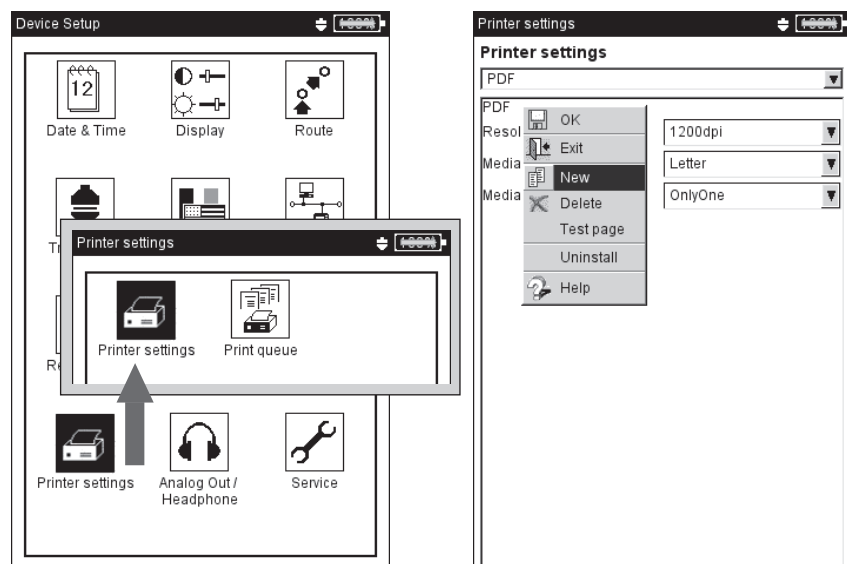

Deleting a print job

- Click on 'Print queue' in the 'Printer settings' menu.
- Select the print job in the list.
- Press the MENU key and click on 'Delete job'.



Device Setup



Printer setting:



Print queue

If a print job is being processed, a print icon appears at the top edge of the screen.

Print job is being processed



Connecting the printer

Only printers with a USB interface can be connected to the measurement device. Connect the printer via the universal communication adapter VIB 5.330 UNV.

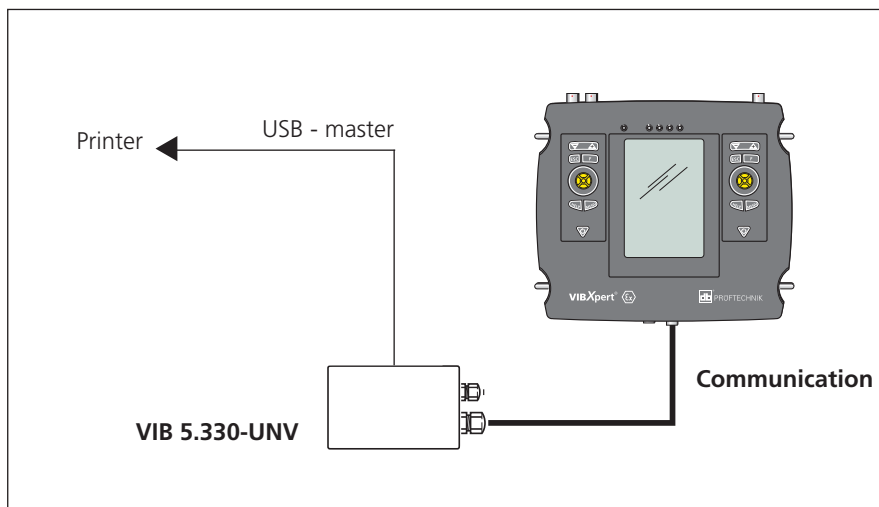

Analog out/headphones

At the analog output (yellow connector), the vibration signal can be picked up with a suitable analysis device (oscilloscope) or listened to via headphones (e.g. VIB 6.671). The output is always the pure, non-integrated signal without the DC component.

To use the yellow connector as the analog output, it must be enabled and parameterized in the Device Setup:

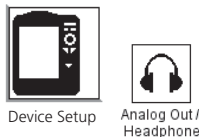

* Only for sensors with a sensitivity of $5.35 \mu\text{A}/\text{ms}^{-2}$

- Click on 'Analog Out/Headphone' in the Device Setup.
- Enable the analog output.
The signal will be output at the analog output until the measurement screen is closed.
- If needed, adjust the standard normalization for the accelerometer. You can choose from: 10mV/g, 100mV/g, 500mV/g*, 1mV/ms⁻²
A maximum output voltage of $\pm 4\text{V}$ provides the maximum possible measurement range, for example of:
80 m/s² at 500mV/g
400 m/s² at 100mV/g
- If the vibration signal is measured with a different sensor type, set a suitable gain factor in the 'Default amplification' menu (x0.1 / x1 / x5 / x10).

To connect the analysis device, use the cable for the analog output (VIB 5.431):

Normalization and amplification for Analog Out

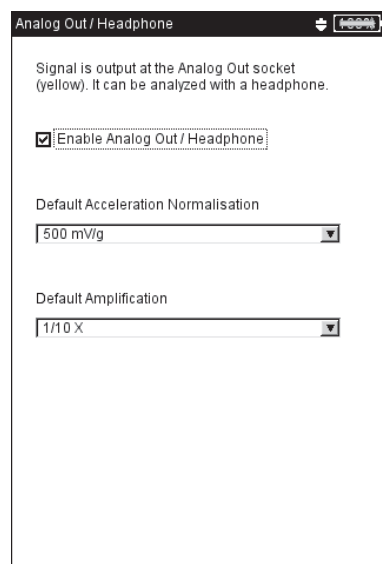

Headphones - VIB 6.671



Connection cable - VIB 6.675

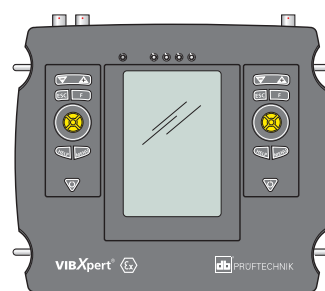

Service menu

- Click on the 'Service' icon to open the Service main menu (see below).

A series of functions are available for service, maintenance and training purposes. For clarity, the numerous settings are grouped into sub-menus (see below):

Device Info

This menu contains device information for service and repair as well as the date of the next offset compensation and calibration.

Offset Compensation

Various factors, e.g. aging or temperature, can cause an offset in the analog electronics. This option makes it possible to maintain the measurement accuracy of the instrument by regularly (approximately every 2 months) compensating the offset.

- Click on 'Offset Compensation'.
- Click on 'Start'. The process takes about 3 minutes.

Factory Defaults

This menu can be used to reset various settings in the instrument to the values set up in the factory. In addition, data that are no longer required in the instrument, e.g. language files, can be deleted.

- Click on 'Reset'.

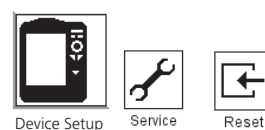
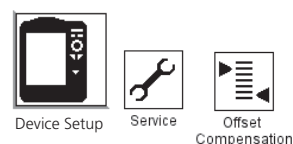
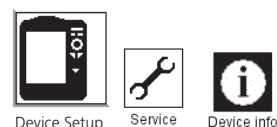
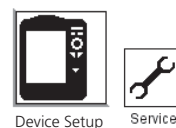

!! RISK of DATA LOSS !!

Pay particular attention to which settings are reset or which data are deleted. This action cannot be undone!



Attention!

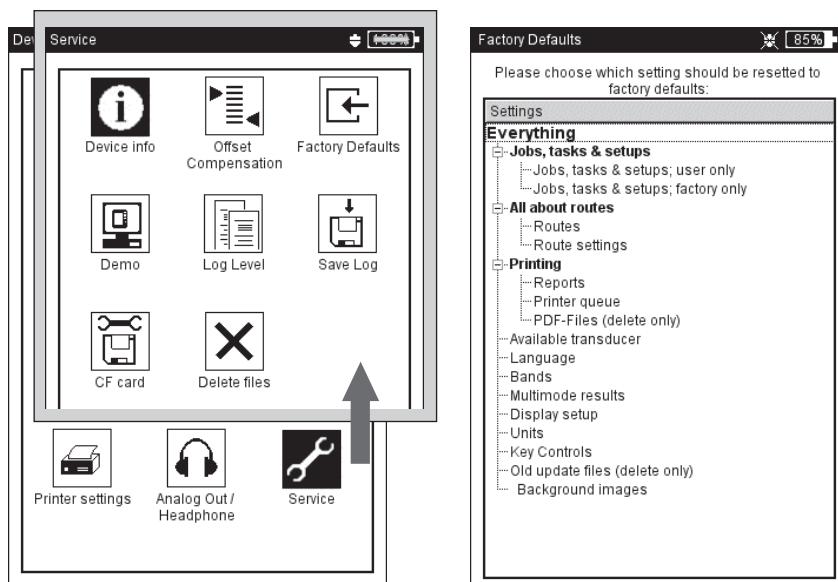

Left:
Service main menu

Right:
Factory defaults

- Click on the respective tree entry and confirm the resulting prompt with 'OK'.
- For reasons of security, the word 'OK' must be entered a second time in the text editor before the action can be carried out.

Demo

For training or demonstration purposes, the VIBXPRT EX screen display can be shown on a PC monitor with the aid of the VIBXPRT demo program. VIBXPRT EX must be switched to 'Demo' mode for this.

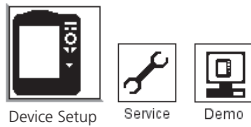

- Click on the 'Demo' icon. The following options can be selected:
 - ETHERNET: VIBXPRT EX can only be operated using the keys on the device. The unit is connected to the PC via a patch/network connection.
 - OFF: Stop 'Demo' mode.

LogLevel

To simplify troubleshooting, the operating steps can be logged in the device and written to a log file. This menu is used to set how much data is to be written to the log file ('LogLevel').

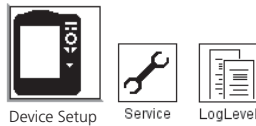

- Click on the 'LogLevel' icon. Select one of the following options:
 - NONE: No logging
 - DEFAULT: Only the most important operating steps are logged.
 - RUNTIME/ ... / SPECIAL USE: The amount of logged information is increased from step to step.



Attention!

The higher the LogLevel is set, the higher the demands on the system resources. Increasing the LogLevel should only be carried in consultation with PRÜFTECHNIK Condition Monitoring.

When processing very long routes set the LogLevel to 'None'.

Left:
Demo mode settings

Right:
LogLevel settings

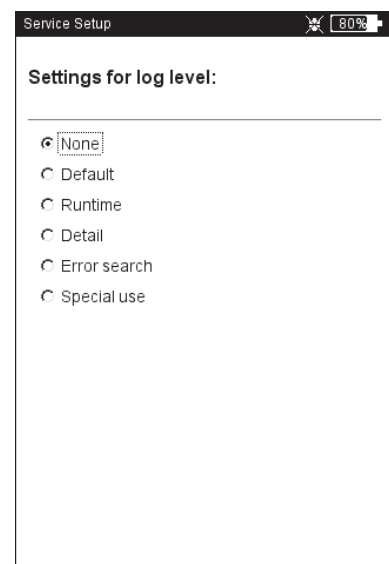
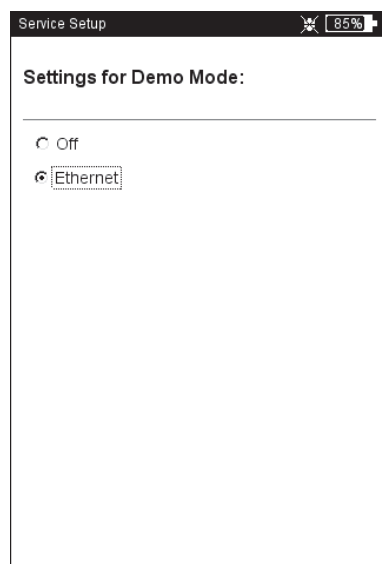

To backup the log file, click on the 'Backup Log' icon and confirm the prompt with 'Yes'. The log file can be transferred to the PC using the 'VIBXPERT update tool'.

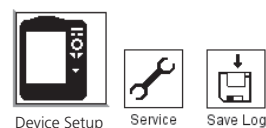

Memory card (CF)

In this menu, you can check and repair the memory card.

FORMATTING: This option is not applicable for VIBXPERT EX.

CHECKING: The degree of fragmentation is checked automatically at specific intervals. Here you can start the check function manually by clicking on the 'Start' button.

REPAIRING: If the file system on the memory card is faulty, an error message appears. If possible, save the measurement data on the PC before starting the repair function.

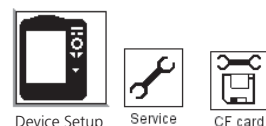

Standardization factor for dB scaling

The amplitude of a spectrum is converted to decibels (dB) with the following formula:

$$A_{log} = 20 * \log(A_{lin} / N), \text{ where } \begin{array}{l} A_{log}: \text{amplitude in dB} \\ A_{lin}: \text{amplitude in linear unit} \\ N: \text{standardization factor} \end{array}$$

In this menu, you can set the standardization factor (default = 1). The scaling that is used for a spectrum (linear or in dB) is defined in the Display Setup (see Chapter 4).

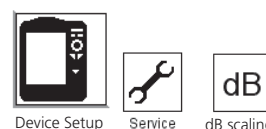

The dB scaling is not available for time signals, overall values and TrendingSpectra. It can also not be applied to frequency-selective band alarms.



Deleting files

Background images and company logos that are no longer needed can be deleted in this menu. Select the data type and press the F key to open the file selection list.

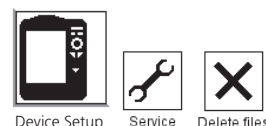

Data transfer

Data is transferred between the measurement device and the laptop/PC either via a direct connection or a network connection. This relates to the following data:

- Measurement tasks to device (route)
- Measurement data to the PC (route, multimode, templates)
- Machine templates
- Software (update)
- Printer drivers
- Data backup to the PC
- Data restore
- PDF and screenshots to the PC

Measurement tasks, measurement data and machine templates are transferred using the OMNITREND PC software. All other data are exchanged via the 'VIBXPERT utility'. This tool can be found on the PRÜFTECHNIK website and must be installed locally on the PC.

Direct connection to laptop/PC

All I/O devices are connected via the universal communication adapter for VIBXPERT EX (VIB 5.330 UNV).

Do not use the adapter in EX areas!

Serial

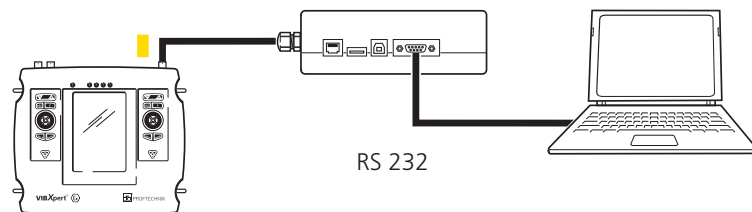

- SERIAL CONNECTION: Connect the adapter cable with the yellow sleeve to the digital port (yellow). Connect the computer and adapter using a suitable serial data cable.

USB

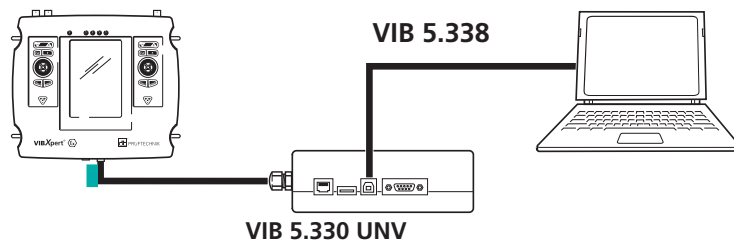

- USB CONNECTION: Connect the adapter cable with the green sleeve to the communication port (green). Connect the computer and adapter with the USB cable VIB 5.338.

Patch

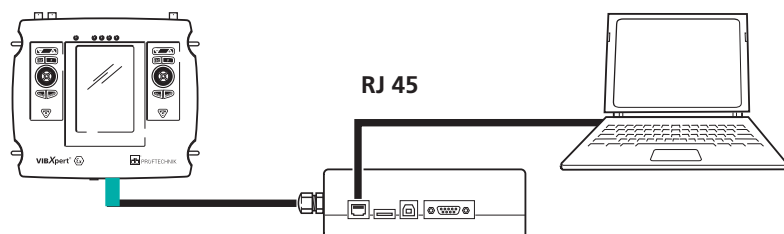

- PATCH CONNECTION: Connect the adapter cable with the green sleeve to the communication port (green). Connect the computer and adapter with a straight patch cable.

Network connection

Data transfer via an Ethernet network requires the following components and information:

- Network connection
- Universal communication adapter for VIBXPERT EX (VIB 5.330 UNV)
- PC with network interface card connected to the network/hub
- IP address and subnet mask of the PC in the network
- UDP port 55737 must be enabled

LAN

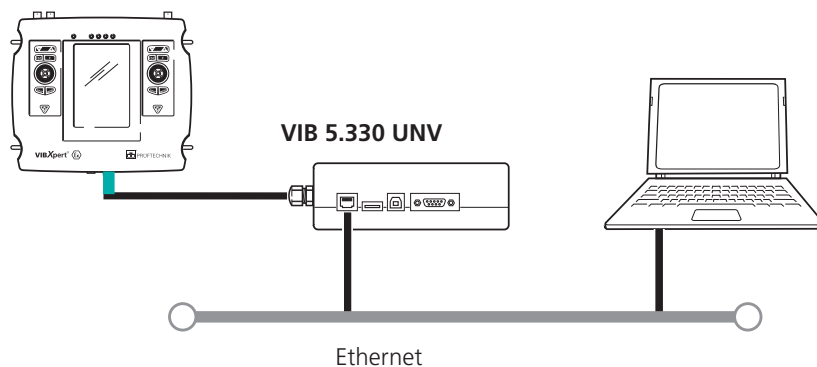

- NETWORK CONNECTION: Connect the adapter cable with the green sleeve to the communication port (green). Connect the adapter to the network connector with a straight patch cable.

Setting up the network communication

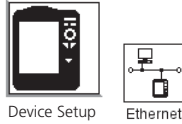

- Connect VIBXPRT EX to the network.
- Switch on VIBXPRT EX.
- Click on 'Device Setup' in the start screen, and then on 'Ethernet':
- Enter a valid IP address for VIBXPRT EX:
Take the first three numbers of your PC's IP address and change the last number only (see also the following instructions). Make sure that the IP address for VIBXPRT EX is not already allocated in the network. Contact your system administrator if you work in a company network.
- In the 'Subnetmask' field, enter the address of the subnetwork where the PC is located.
- If necessary, enter the address of the gateway in the 'Standardgateway' field. If no gateway is used, set the field to '0.0.0.0'.
- To accept the settings, press MENU and click on 'OK'.

Left:
Open menu for
network communication

Right:
TCP/IP settings for
network communication

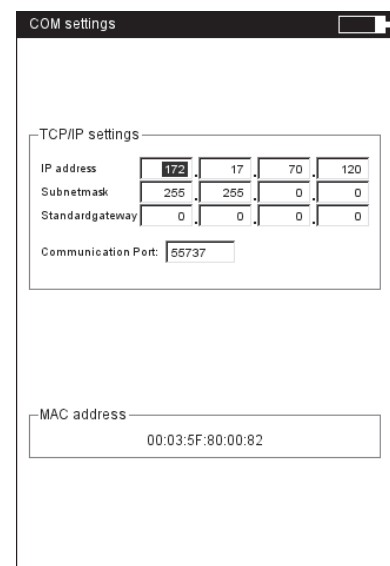
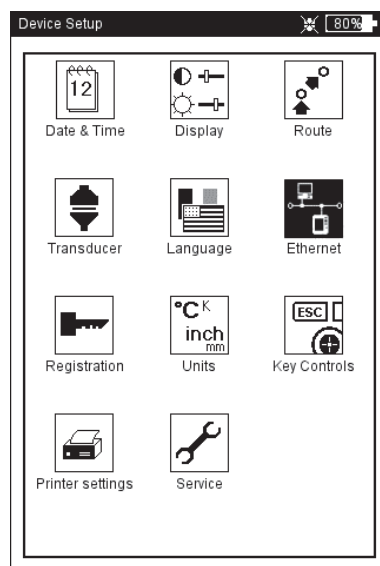

IP address of the local PC in the network

If the IP address and the subnet mask of the PC are not known, ask your network administrator or find it yourself on the PC:

- Open the Windows command line editor ("cmd").
- Enter "ipconfig -all" .

```

C:\WINNT\System32\cmd.exe
C:>ipconfig -all
Windows 2000 IP-Konfiguration

Hostname . . . . . : pc_achter
Primäres DNS-Suffix . . . . . :
Knotentyp . . . . . : Hybridadapter
IP-Routing aktiviert. . . . . : Nein
WINS-Proxy aktiviert. . . . . : Nein
DNS-Suffixsuchliste . . . . . : pruftechnik.com

Ethernetadapter "LAN-Verbindung":
    Verbindungsspezifisches DNS-Suffix: pruftechnik.com
    Beschreibung. . . . . : 3Com EtherLink XL 10/100 PCI f³r vol
Istündige PC-Verwaltung-NIC (3C905C-TX) . . . . . :
    Physikalische Adresse . . . . . : 00-04-76-0C-4D-7B
    DHCP-aktiviert. . . . . : Ja
    Autokonfiguration aktiviert . . . . . :
    IP-Adresse . . . . . : 172.17.5.59
    Subnetzmaske . . . . . : 255.255.0.0
    Standardgateway . . . . . :
    DHCP-Server . . . . . : 172.17.1.61
    DNS-Server . . . . . : 192.168.10.1
    Primärer WINS-Server . . . . . : 172.17.1.40
    Sekundärer WINS-Server . . . . . : 172.17.1.3
    Lease erhalten. . . . . : Dienstag, 2. Dezember 2003 10:37:32
    Lease läuft ab. . . . . : Dienstag, 2. Dezember 2003 11:37:32

C:\>
  
```

Command line - cmd

Example: The screen displays the IP address and the subnet mask of a PC in a network:

IP address: 172.17.5.59
Subnet mask: 255.255.0.0

Entering a fix IP address for the local PC

You must assign a fixed IP address to the computer if you connect the computer directly to the measurement device with a patch cable. Please refer to the operating systems documentation for further assistance.

Update

Technical developments and improvements to the firmware are transferred to the device via an update. The latest firmware can be downloaded from the PRÜFTECHNIK website.

Preparation:

- Backup the measurement data into the OMNITREND database.
- Connect the device to the mains supply. Otherwise, the update procedure will not start.
- Install the 'VIBXPERT update tool' on the PC. The program is available on the PRÜFTECHNIK website.
- Download the latest firmware version from the PRÜFTECHNIK website. The file name includes the version number (e.g. 'VXP_220_build503.ptz') and the extension 'ptz'.

Update procedure:

- Connect VIBXPERT EX to the network / or to the PC (USB).
- Switch on VIBXPERT EX.
- Start the 'VIBXPERT update tool'* on the PC and click on <Next> to call up 'Step 2':

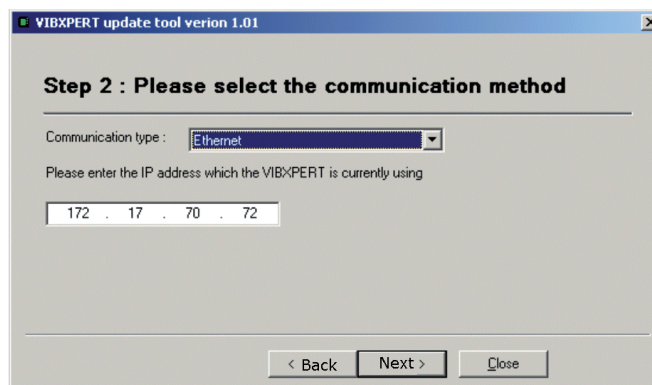

- Set the 'Communication type' to 'Ethernet' (or 'USB').
- Only with network connection: Enter the IP address of the VIBXPERT EX.
- Click on <Next>:

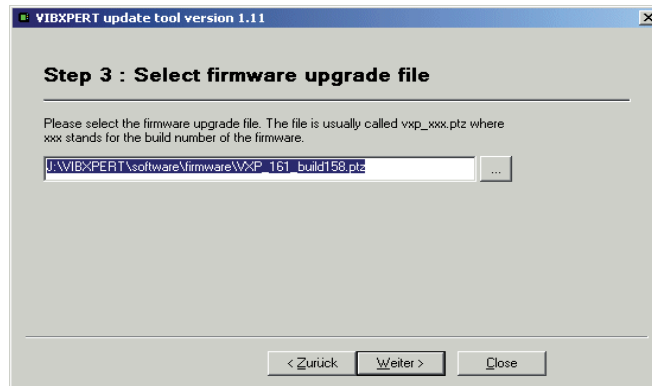

- Select the update file on the PC.
- Click on <Next>:

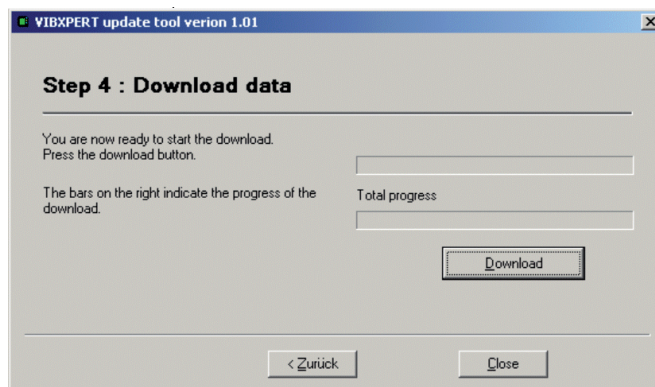

- Click on <Download> to start the data transfer to VIBXPert EX.
- After the data transfer has finished, click on <Close> to close the program.
- The device switches itself on and off repeatedly until the update is completed. This process generally takes a few minutes. Wait for the start screen to appear.

The version number appears in the lower right corner of the start screen:



Chapter 3: Measurement

VIBXPert EX can carry out measurements in the following operating modes:

Multimode:

VIBXPert EX can be used as a multimeter to measure characteristic overall values or signals for the diagnosis of machine conditions. The results can be saved and read in for evaluation and archiving by the OMNITREND PC software.

Route and Machine templates:

As a data collector, VIBXPert EX works through a route or machine template. A route is a compilation of measurement tasks that are measured at regular intervals. A machine template contains measurement tasks that are measured repeatedly on machines of the same type, such as during service interventions or acceptance measurements on-site at the machine manufacturer's. Routes and machine templates are created in the OMNITREND PC software; the results are read into the OMNITREND PC software for evaluation and archiving purposes.

Balancing:

VIBXPert EX can be used for dynamic balancing* in one or two planes.

* 'Balancing' mode is described in the VIBXPert EX 'Balancing' manual (VIB 9.806.G).

Preparation

Before beginning a measurement, ensure that ...

- ... the battery is fully charged
- ... the device settings are set properly (date, units, ..)
- ... the required measurement tasks are created and stored in VIBXPert EX.
- ... the required sensors and cables are laid out and in good condition; the RPM sensor requires a support to perform RPM measurements!
- ... permanently mounted measurement locations are in good condition. If necessary, clean them and repair any damage.
- ... recesses for hand-held probes are prepared.

*Measurement variable:

Vibration acceleration,

Vibration velocity

Vibration displacement as overall value,
time signal or spectrum respectively

Shock pulse,

Temperature,

RPM,

...

What is a measurement task?

To carry out a measurement, VIBXPRT EX requires information on the type of measurement variable*, the sensor being used and, if necessary, data for the evaluation of the result. Information as to whether the RPM must be recorded with each measurement is also required. This data set is designated as a 'measurement task' and forms the basis for each measurement with VIBXPRT EX.

To simplify the preparation of a 'multimode' measurement and to save the user from having to enter the required data, VIBXPRT EX already contains a comprehensive collection of predefined knowledge-based measurement tasks. The user is only allowed to change the transducer and to alter the measurement channel in these measurement tasks. If extensive changes to the measurement parameters are required, it is better to create a new measurement task.

In the 'Route' and 'Machine Template' operating modes, VIBXPRT EX receives the measurement tasks directly from the OMNITREND PC software. Only a few of the measurement parameters here can be changed (transducer, measurement channel, RPM entry).

The following overview shows the structure of a measurement task in VIBXPRT EX:

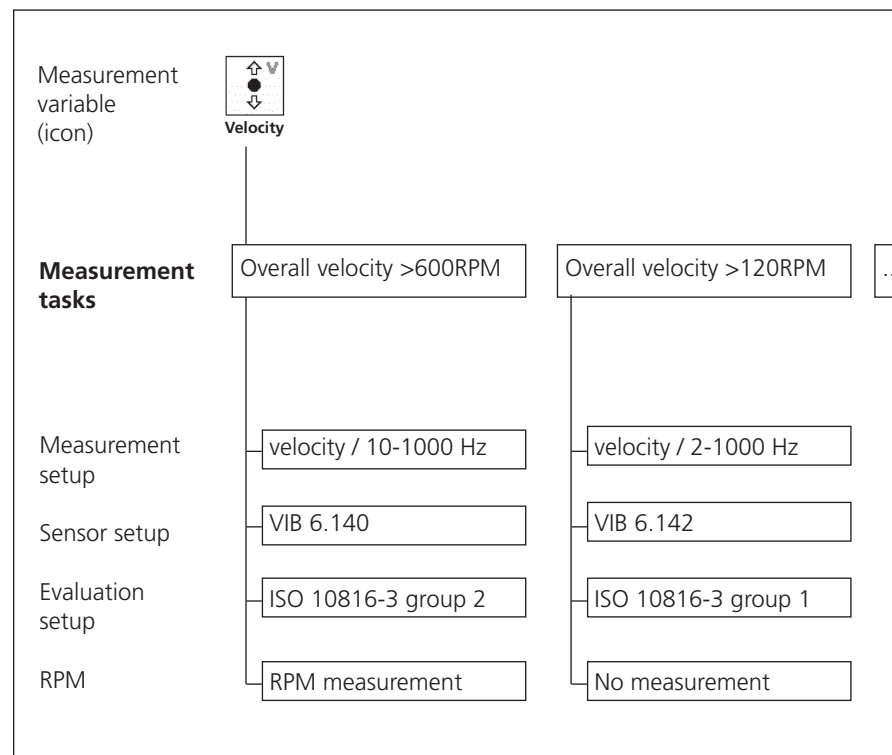

The measurement tasks are sorted according to measurement variable* and assigned a measurement icon in the selection screen. If you are in the 'Multimode' operating mode for example, all measurement tasks of the 'Vibration velocity - Characteristic value' measurement variable appear under the icon shown above. The letters 'a', 'v', and 'd' in the icon stand for 'Acceleration', 'Velocity' and 'Displacement'.

Multimode: Measurement, Analysis, Diagnosis

To activate the 'Multimode' mode, click on the corresponding symbol in the start screen. The measurement tasks appear in the selection screen (see below). The measurement task for the marked icon is displayed below the icon field.



Multimode

The measurement tasks are grouped into three tabs: Overall (characteristic) Values, Signals, Advanced (measurements). Certain measurement tasks only appear if the corresponding module is registered.



The current tab sheet is highlighted with a black frame. To change the tab sheet, press the '+/-' key or highlight the tab sheet with the joystick.

Typical workflow of a measurement

This section shows you how to carry out a measurement in multimode mode if the preparations have already been made. A schematic of the workflow of a measurement is shown below.

The setting options that are available before, during and after a measurement are described in the following section. The evaluation of the results on the instrument* is described in Chapter 4.

* Multimode measurements can also be imported and evaluated in OMNITREND.

Starting a measurement:

- Highlight the measurement icon in the selection screen.
- Connect the sensor.
Sensor and measurement channel are displayed in the info field.
- Click to start the measurement.

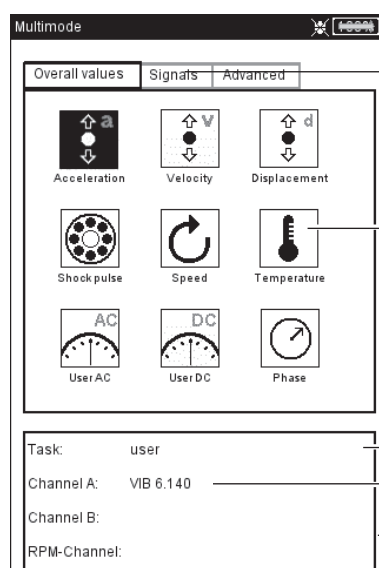
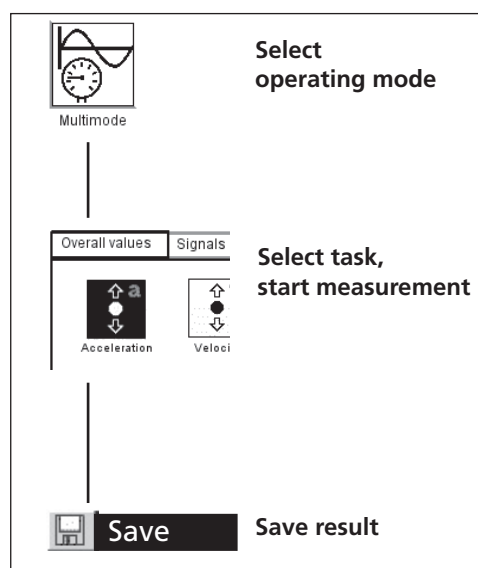

Multimode selection screen for overall value measurements

Tab

Measurement variable (icon)

Measurement task

Sensor type: VIB 6.140

Info field



Note

Before every measurement, VIBXPRT EX checks that the sensor and cables are correctly connected if sensor detection is activated in the device setup. In measurements with trigger (phase, orbit,...) the trigger signal is monitored (green LED flashes at every pulse). If the trigger signal fails during measurement, the green LED flashes. The measurement must then be repeated.

Continuous measurement (live mode)

In 'live mode', the signal is measured and displayed continuously. This lets you check the signal and the stability of the measurement. It is not available for time-limited measurements, such as the coastdown curve and impact test. The live mode is activated in the Display Setup or by keeping the joystick pressed when the measurement starts. The actual data collection begins when you release the joystick, or press the joystick again.



Note

Measurement progress is indicated by a bar at the top edge of the screen. In the live mode, the 'Live' symbol appears in the title bar and the progress bar remains at 0% (see below).

Save result

After completing a measurement, the blue LED lights if no measurement failures have occurred and no limit value has been exceeded.

- Press the MENU key and click on 'Save' (see below). The file manager opens.
- Enter a file name.

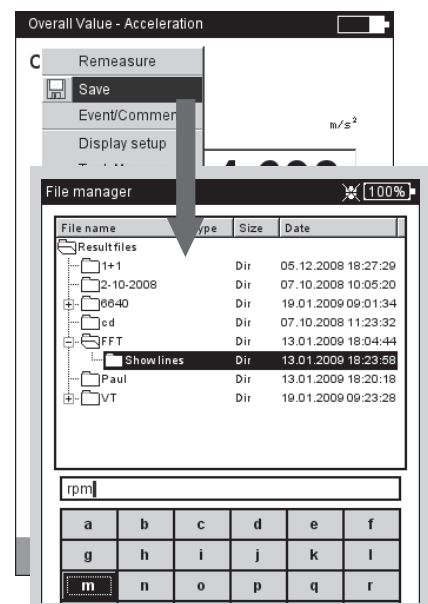
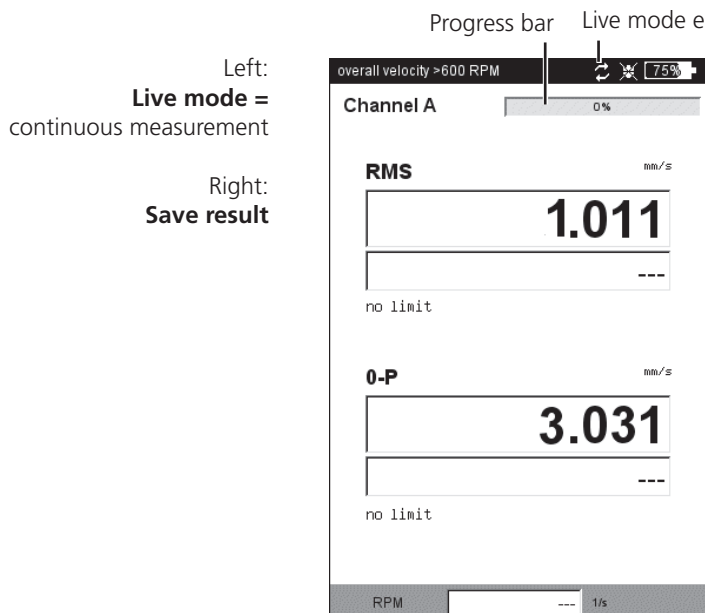

Measurement of a route

The 'Route' mode processes a specified number of measurement tasks which are carried out regularly according to a specific schedule with VIBXPERT EX. The measurement tasks for a route are compiled on the PC using the OMNITREND software.

Preliminary remarks

A route can be carried out in the specified sequence or in any order; it can also be interrupted at any time and can be started again at a later point in time. It is possible to skip individual elements in the route if an aggregate is not in operation, for example. The skipped measurement tasks are counted as processed. When the route has been processed, it can be transferred into the OMNITREND database for evaluation and in order to archive the results on the PC.

The following diagram shows the typical workflow of a route:

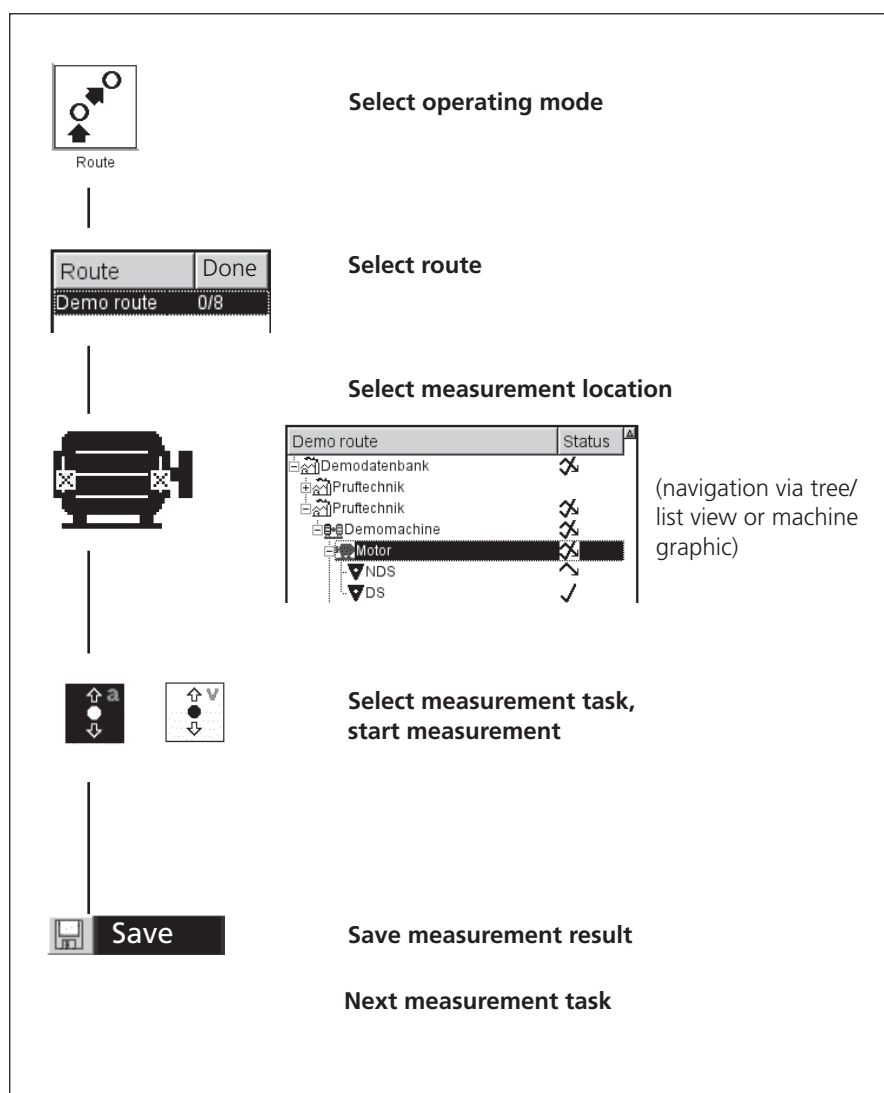

Sequence of a route measurement

*For more information, see also Chapter 5 'Measurement tasks'

As well as the standard measurement tasks*, the following route-specific measurement tasks can be included:

Adaptive measurement task

An adaptive measurement task automatically adapts the sequence of the route to the condition of the machines. If these run within the permissible range, the data collector only records overall values. This keeps the resulting volume of data and number of measurement tasks to a minimum.

If an overall value exceeds the selected warning or alarm level, additional diagnosis measurements are automatically performed. These additional measurement tasks (spectrum, overall values) are stored in the OMNITREND PC software for each machine and are only called up if the operating condition of the machine changes.



Note

The threshold value which triggers the diagnosis measurement is defined in the OMNITREND software as an 'adaptive trigger'. If no 'adaptive trigger' is defined, the diagnosis measurement is triggered when the lowest threshold value is exceeded.



Visual inspection

A visual inspection task includes all types of data gathering that are based on defined conditions of a machine and that cannot be measured with electrical signals. For example, the degree of contamination of an aggregate, the belt tension on a drive or the fill level of a tank can all be ascertained without having to measure a signal. The possible conditions in OMNITREND are defined in the form of a 'visual inspection task' (e.g. 'Aggregate clean / slightly contaminated / heavily contaminated'). The machine condition is inspected in situ and the applicable option selected from a list.



Manual entry

This measurement task allows numerical measurement values that were acquired from another measurement device or read on a display instrument (e.g. flow rate, pressure,...) to be entered in VIBXPERT EX.

Notes about routes

A route can contain the following information:

- Alarm and warning thresholds
- Reference results that define the good machine condition.
- Historic measurement results
- Frequency marks
- Master data of the route (name, user, version, ...)

To display the master data, highlight the route in the route list (see below), press the MENU button and click on 'Info'.

Typical workflow of a route

This section explains how to process a route if all the preparations have already been made. The menu options that are available to you are described in one of the following sections. The evaluation of the results on the device* is described in Chapter 4.

Start Route

- Click on the 'Route' icon in the start screen.
All routes available in the data collector are displayed in the route list (see below). The right column ('Done') specifies the number of measured locations / total measurement locations for each route. The lower info field shows for the selected route the date and time when it was loaded into the data collector and when it was measured last.
- Click on the route you wish to measure.
The route is displayed either as a list or tree - depending on what display mode is set.
- Use the joystick to navigate to the measurement location where you would like make a measurement and click on it.

* Route measurements are usually evaluated in OMNITREND.



Route	Done
Route in filling station	2/14
daily route	0/8
weekly route	0/4

Downloaded:	01.09.2004 13:47:51
Last measured:	01.09.2004 14:01:40

Route list

Info field



Note

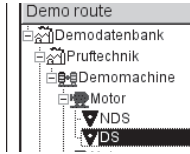

Notes about the tree view:

- If the tree is not fully opened, click on a node ('Machine train' or 'Machine') (see figure to the left).
- If the 'Graphic Route' option is activated, you can select the measurement location using the machine graphic (see left).
- If the branch cannot be opened up to the measurement location level, press MENU and select 'Expand' -> 'Meas. points' (s. below)

Notes about the list view:

- Only the measurement locations appear in the list view.
- The order of the measurement locations in the list view can vary from the order in the tree view. The list view indicates the order of the route. The tree view indicates the sequence in the measurement location database.

- Select the measurement task (see below), and connect the sensor specified in the info field.
- Click to start the measurement.



Note

Reference measurements must be carried out first (e.g. RPM measurement for the normalization of a bearing measurement).

Various route options shorten the measurement times. Depending on which option is enabled in the Route Setup, the measurements can take place virtually automatically.

- Select the next measurement task and start the measurement.

If all measurement tasks have been completed, the message 'Route is finished!' appears.

Left:
Measurement tasks in the route

Right:
Route in tree view / list view

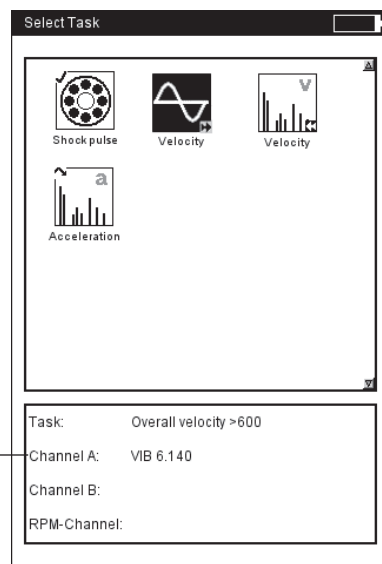

Measurement channel and sensor

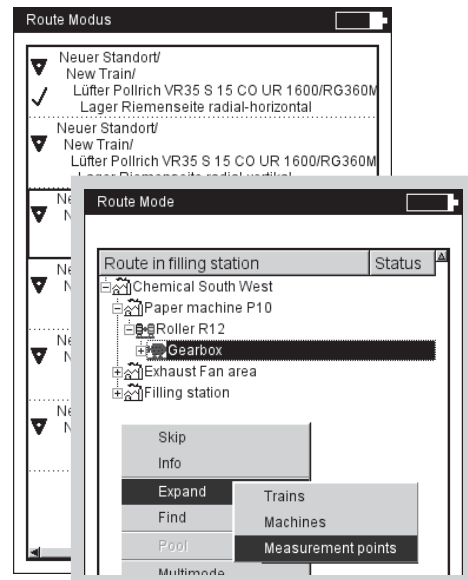

Icons

Meas. task



- Measurement task completed
- Measurement task skipped
- Adaptive task
- Diagnostic task, triggered by 'adaptive trigger'
- R Reference RPM
- AWP Result exceeds alarm, warning, prewarning threshold

Status in Tree view / List view

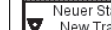
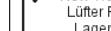

Status in Tree view / List view

- (empty): Partly/ not processed
- ✓ : Completely processed
- ✗ : Skipped
- ✗✓ : Partly processed and skipped
- contains Multimode result
- contains Event / Comment
- Near location (channel A)
- Meas. location for triax sensor (X axis)
- AWP Result exceeds alarm, warning, prewarning threshold
- L line speed; the production line speed of the aggregate must be entered before starting the measurements.

Status in Tree view

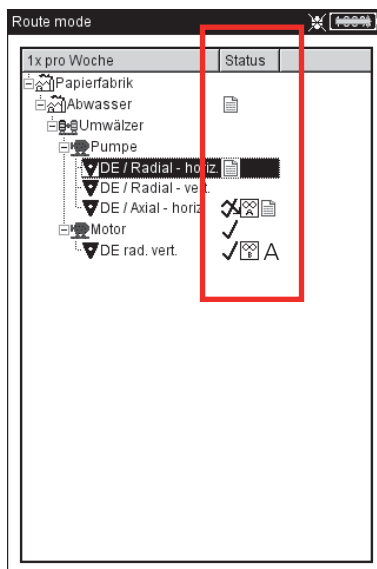



MENU functions in the tree / list view

- Press the MENU key in the tree / list view (see below):

SKIP / UNSKIP

If a machine is not in operation during a route, you can skip all measurement tasks planned at this machine. The measurement tasks that are associated with the highlighted route element and were not measured are left out. This procedure is reversible.

EVENT/COMMENT

Enter an event or comment.

DELETE RESULT

Delete the measurement result for the selected element and all sub-elements. This procedure cannot be reversed!

SET UNMEASURED

Change the status of the associated measurement task to 'not measured'. All existing results are retained.

RESET REFERENCE RPM

The reference rpm of the machine train or the production line speed is reset and can be measured again.

BREAK DOWN MULTITASK

All the multi-measurement tasks that are assigned to the highlighted element are broken down into the individual measurement tasks. This procedure is irreversible!

'BREAK NEAR LOCATION' OFF

The optimized coordination of the measurement tasks for neighboring measurement locations is disabled. The measurements no longer take place simultaneously.

Left:
**Menu functions
in the Tree view**

Right:
Info dialog

For mechanically coded
VIBCODE-locations, the code ring pat-
tern can be shown.

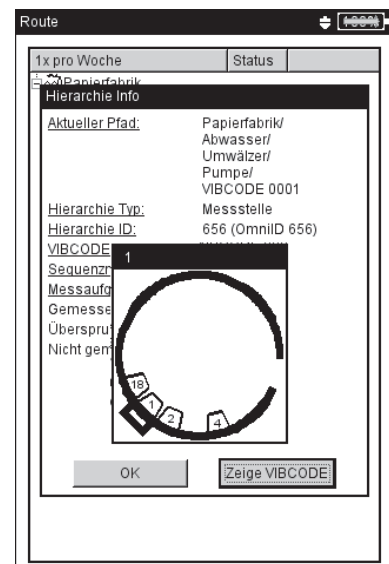
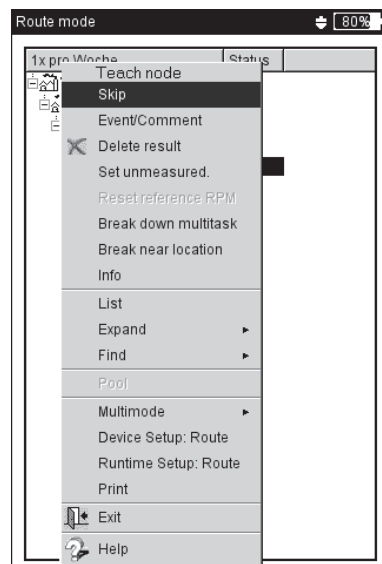

INFO

The following information is displayed for the highlighted element

- Path in the OMNITREND database
- Hierarchy type (e.g. train)
- ID (identification number in the database)
- Sequence number = order of the elements in the route list view
- Task statistics (measured, skipped, not measured)
- VIBCODE code number and code ring pattern ('Show VIBCODE').

LIST (TREE)

Toggle route display mode: List view / Tree view.

***EXPAND / (HIERARCHY)**

If the hierarchies are not all displayed in the tree view, they can be displayed with this function.

***FIND > CRITERIA**

Search function; The route can be searched according to name or ID number of an element. Enter the search item in the text editor.

***POOL / ROUTE**

Display optional measurement tasks to be measured as required / switchover to route mode.

MULTIMODE > START / RESULTS

Change to 'Multimode' mode to perform measurements which are not programmed in the route. After the measurement, press the ESC key to return to route mode. The 'Multimode' results are automatically allocated to the element in the route from which the operating mode was changed.

To display the results, select MULTIMODE > RESULTS and click on the saved measurement result.

***DEVICE SETUP - ROUTE:**

Change the basic settings for route mode. The changes then also apply for all other subsequent route measurements.

RUNTIME SETUP - ROUTE:

Change the following parameters for the active route:

- Standard sensor for vibration measurement; a change is only possible when this option is disabled in the Device Setup.
- Measurement channel = A, B or Auto; must be set to 'Auto' for 'Near locations' und triaxial sensors.
- RPM entry: Manual entry of the RPM value (yes/no).

PRINT

Print out measurement tasks and results (characteristic values only).

* The 'Menu' function is only available in the tree view

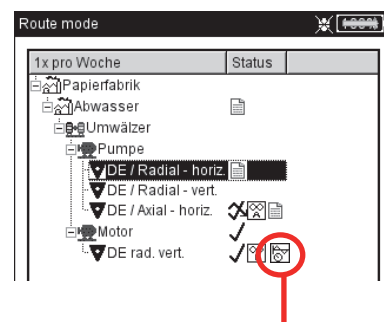

Measurement location contains 'Multimode' measurement results



MENU functions in the measurement task selection screen

- Press the MENU key in the task selection screen (see below):

SKIP/ UNSKIP

A measurement task can be skipped if it cannot be measured.

EVENT / COMMENT

Enter the event and, if necessary, a supplementary comment to explain the result. It is also possible to use this entry for skipped measurements.

BREAK DOWN MULTITASK

Break down multi-measurement task (see previous section).

SHOW ADAPTIVE TASK

Adaptive measurement tasks contain additional measurement tasks which are automatically carried out for diagnosis if a threshold value is exceeded. This function shows these additional diagnosis measurements.

TASK MANAGER

To check the measurement settings before the measurement, call up the Task Manager here. The settings cannot be changed.

DISPLAY RESULT

The results of a task that has already been carried out can be displayed. Either the last result saved last or a trend appears.

DELETE RESULT

Delete the measurement result for the selected measurement task. This procedure cannot be reversed!

SET UNMEASURED

Change the status of the measurement task to "unmeasured". Existing results are retained.

MENU functions
in the task selection screen

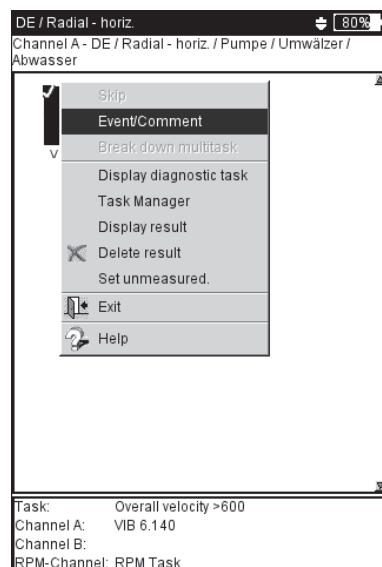

Measuring with a machine template

A 'Machine template' is used if it is necessary to carry out measurements on machines of the same type. The measurement locations are always at the same position and the measurement tasks are identical for each machine. Typical applications are service measurements or acceptance measurements (production tests) on-site at a machine manufacturer's. Machine templates are created with the aid of the OMNITREND PC software.



The following diagram shows the typical workflow of a measurement:

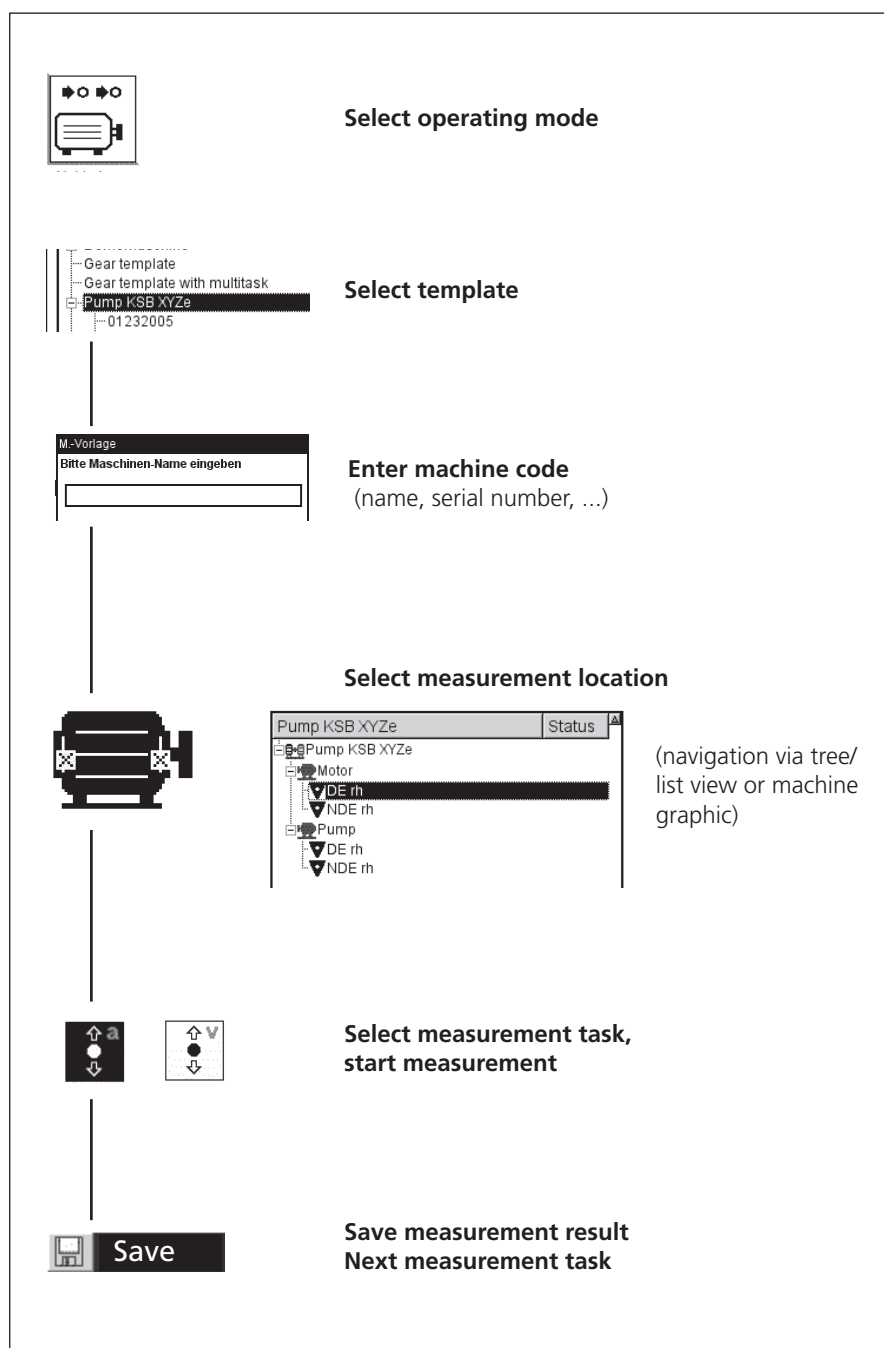

Measurement - Machine template

Preliminary remarks

In principle, a machine template is set up like a route and resembles a route in operation and workflow (see previous section). The differences to a route are described in the following points:

Machine description

This must be identified with a name before the first measurement. Additional data for documentation purposes (such as serial number, model, customer, and tester) can also be entered.

Production test

During a production test, the automatic call up of the next measurement task is deactivated. In this way it is possible to carry out the same measurement task under different operating conditions within the scope of a production test. The remaining measurement tasks are called up manually by joystick navigation.

To create a template for a production test, the 'Production test' option must be activated in the OMNITREND template editor (see below).

In the case of templates for production tests, the measurement location hierarchy on the machine is only shown in the tree view. A list view is not available. The number of measurements carried out for each measurement location and measurement task appears instead of the status information.

Number of measurements per measurement task (in this case: 0.3)

Left:
Template for 'Production test'
and selection of the meas. task

At location 'Motor Axial':
3 measurements per 2 measurement tasks
(= 1.50)

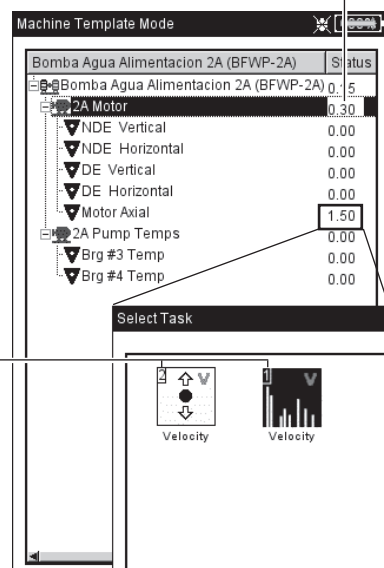

Right:
'Production test' option
in the OMNITREND template editor

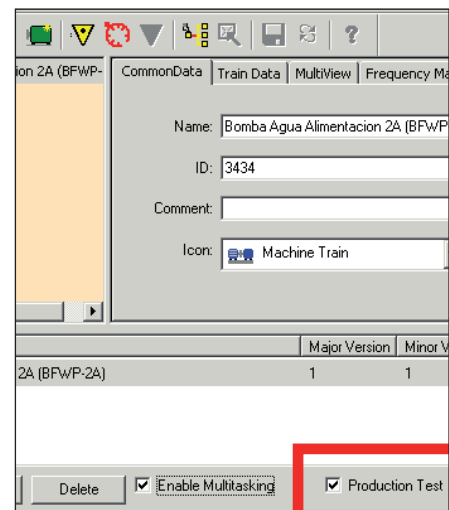

Start measurement

- Click on 'Machine template' in the start screen.
A list of the available machine templates appears (see below). Machines where measurements have already been carried out appear subordinate to the associated template. The number of the measured measurement location and the total number of measurement locations is indicated in the right column ('Done') for each machine.
- The info field for the highlighted machine at the bottom shows when the corresponding template was loaded into the data collector and when the last measurement was carried out.



To continue the measurement on a machine, click on the corresponding subordinate machine.



Note

- Click on the template that you want to use for the measurement. The 'Machine description' dialog appears where only one name for the new machine (e.g. 'Machine 2') is specified as standard.
- If you do not want to enter any further information, press the MENU key and click on 'OK' to accept the name.
- Otherwise press the MENU key, click on 'Details' (see below) and, if necessary, enter the necessary data as follows:
 - Position the cursor in the corresponding text field and click with the joystick to open the text editor.
 - After entering the data, press the MENU key and click on OK.

You can change the machine description at any time.

Select machine template

Machine Template	Done
Bomba Agua Alimentacion 2A (BFWP-2A)	--/7
↳ Machina 1	0/7

Machine description

Machine Name: Machine 3

Customer: _____

Model: _____

Road number: _____

Tester: _____

Order number: _____

Last measured: Unmeasured

Select machine template

Machine Template	Done
DEMO	--/5
↳ test	0/5
↳ Demomaschine	--/5
↳ Gear template	--/5
↳ Gear template with multitask	--/5
↳ Pump_KSB_XYZe	--/4
↳ 01232005	1/4
↳ 01232005	4/4
↳ Template Pump	--/4
↳ gus	--/1

Downloaded: 08.09.2006 10:26:59

Last measured: Unmeasured

Left:
Enter machine details

Right:
Machine template list

Template

Machine

Info field

* not in the case of templates for production tests

The template then appears, which – like a route – is displayed as a tree structure or in the form of a list* (see section 'Route'). The following steps are identical to those in the 'Route' section:

- Click on the measurement location.
- Select the measurement task, and connect the sensor specified in the info field.
- Click on the measurement task to start the measurement.
- Select the next measurement task and start the measurement.

Once all measurement tasks have been completed, the following message appears: 'Template is finished!'

Options before, during and after a measurement

In addition to the information given in the previous sections, the options for the measurement are described here.

Aborting a measurement

- Press the ESC key during the measurement.



Repeating a measurement

- In the results screen, press the joystick again, *or* ...
- Press the MENU key in the results screen and click on 'Remeasure'.

Saving a result

Route / Machine template:

- After the measurement confirm the 'Save?' prompt. If the 'Automatic save' option is activated, the result is automatically saved. For measurement tasks that have already been measured, the current result can be appended to the saved measurement data or can overwrite them.

Multimode:

- Press the MENU key after a measurement and click on 'Save'. In the case of a trend, the result is saved in the corresponding existing data set.



Changing the measurement channel

Multimode:

- Highlight the measurement type in the selection screen.
- Press the MENU key, and click on 'Task manager'.
- Click on the 'Measurement Channel' field to activate it (see below) and then select the measurement channel (A, B , A/B*).
- To save the change, press the MENU key and click on 'OK'.

* Channel A/B:

The overall value, spectrum and time signal can be measured on each of the two channels simultaneously if the 2-channel module is registered.

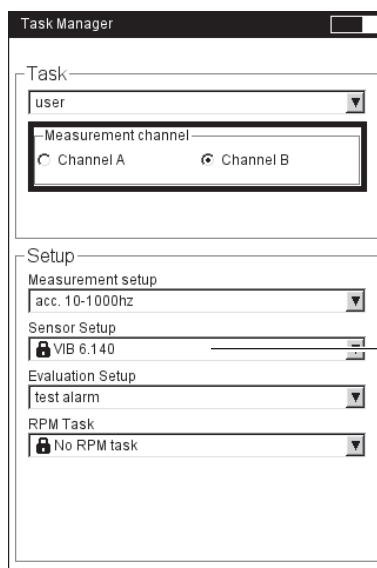
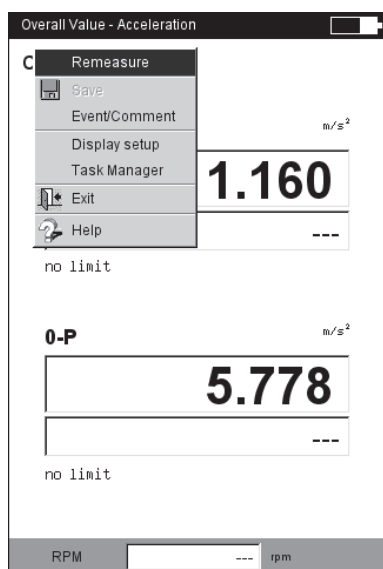

Left:

Repeat measurement

Right:

Change meas. channel / sensor
in the task manager

Sensor

Changing the measurement channel

Route/machine template:

- In the tree/list view, press the MENU key and click on 'Runtime Setup: Route' (see below).
- Select the measurement channel (A, B, Auto = the channel set in OMNITREND). 'Auto' is required when the route uses the 'Near location' or 'Triax sensor' function.

Changing the sensor

Multimode:

- Highlight the measurement type in the selection screen.
- Press the MENU key, and click on 'Task manager'.
- In the 'Sensor Setup' field click in the pulldown menu and select the required sensor.
- To save the change, press the MENU key and click on 'OK'.

Route/machine template:

- In the tree/list view, press the MENU key and click on 'Runtime Setup: Route' (see below).
- Activate the 'Use default sensor' option.
- Select the sensor that is to be used for all vibration measurements on the route/in the machine template.



Note

Do not activate when the route uses the 'Near location' or 'Triax sensor' function!

A default sensor can be set up for all routes in the 'Route' device setup.

Entering the RPM manually

- Route/machine template:
 - In the tree/list view, press the MENU button and click on 'Runtime Setup: Route' (see below).
 - Activate the 'Manual RPM input' option.

Left:
Select Runtime Setup
(Route)

Right:
Change measurement channel
(Route)

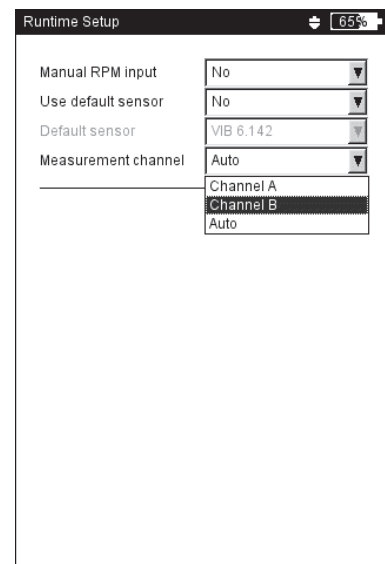
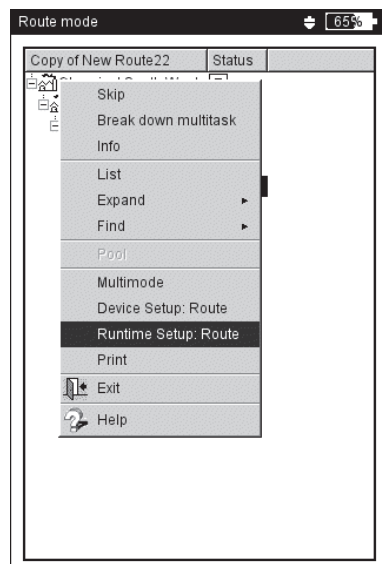

Use this option when you do not have an RPM sensor on the route and need to perform measurements that require the RPM (e.g. roller bearing condition, order-based spectra). If the measurement task already has information on the RPM, this option is ignored.

Changing the measurement task (M)

- Highlight the measurement type in the selection screen.
- Press the F key. A list appears with all the measurement tasks set up for this measurement type.
- Click on the required measurement task (see below).

M = in Multimode only



Setting up a new measurement task (M)

VIBXPERT EX has a large selection of frequently used measurement tasks* that can be extended by user-defined measurement tasks if necessary. To configure a new measurement task, proceed as follows:

- Highlight the measurement type in the selection screen.
- Press the MENU key and click on 'Task Manager'. The Task Manager appears and can be used to set up the new measurement task.
- Click on the 'Measurement task' pulldown menu.
- Press the MENU key and click on 'New'. The text editor appears.
- Enter a name for the new measurement task.
- Change the measurement channel if necessary.
- Select the setups for measurement (see below), sensor**, evaluation or RPM in the 'Setup' field of the pulldown menu. If the matching entry cannot be found, a new setup must be created (see next section).
- Then press the MENU key and click on 'OK'.

* Preconfigured measurement tasks/setups are marked with a lock and cannot be edited (except for transducer & channel).



Open 'Task Manager'

**Initially only the 'available transducers' appear in the transducer setup. To display all transducers, click on the bottom list entry '...more transducers'

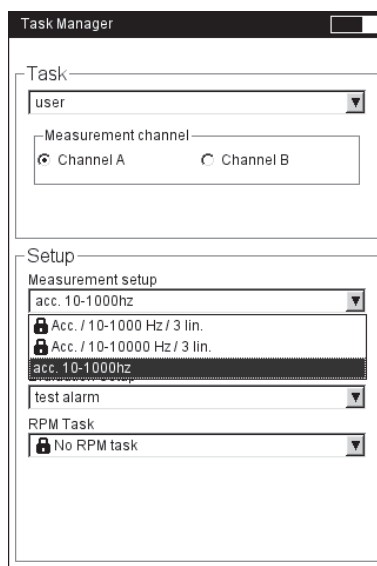
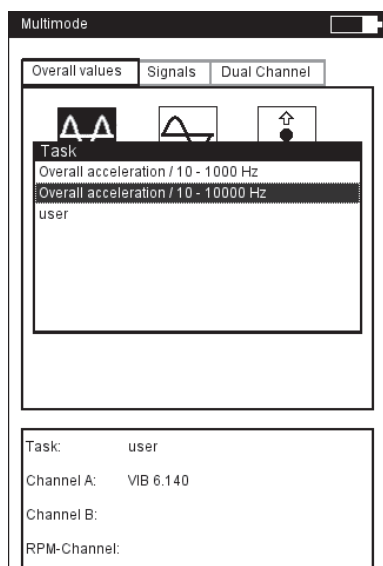

Left:
Changing the measurement task

Right:
Task Manager

Setups for measurement, sensor, evaluation and RPM measurement

M = in Multimode only

Creating a new setup (M)

You can only create a new setup for the measurement, evaluation or rpm for user-defined measurement tasks. You can also create a new sensor setup for measurement tasks preset at the factory.

How to create a new setup:

- Open the 'Task Manager' (see below and previous page).
- Select a user-defined measurement task.
- Click on the pulldown menu where the new setup should be created.
- Press the MENU key and click on 'New' (see below).
- Enter a name in the text editor.
- Then set up the Setup parameters:
 - Press the MENU key.
 - Click on 'Edit'.
 - Change the parameters as required: see sections A to D on the following pages.
- To save, press the MENU key and click on 'OK'.

How to review the setup parameters:

- Open the 'Task Manager'
- Select the setup in the respective pulldown menu.
- Press the MENU key, and click on 'Show'.

In which measurement task was the setup already used?

- Open the 'Measurement Task Manager'.
- Select the required setup.
- Press the MENU key and click on 'Use'.

Left:
Open the Task Manager

Right:
Create a new setup

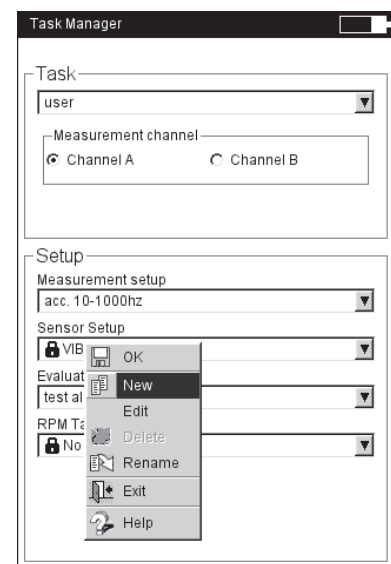
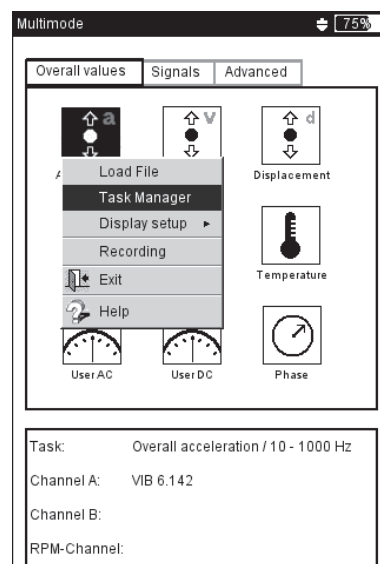

A1: Meas. setup parameters in the 'Overall values' & 'Advanced' tab

MEASUREMENT QUANTITY: Fixed; selection is carried out via the measurement icon. Exception: The measurement quantity can be changed for the 'Orbit', 'Phase' and 'Coastdown' measurement tasks.

SAMPLE FREQUENCY (TIMEWAVE RECORDER): The sample frequency for the time signal defines the maximum upper frequency and influences the maximum measurement time.

MEASUREMENT TIME: Duration of an individual measurement; this depends on the lowest frequency.

LOWER/UPPER FREQUENCY: Frequency range of the vibration measurement. The DC component of the signal can be recorded for the 'Vibration displacement' and 'User-defined' measurement parameters (lower frequency = DC).

AVERAGING TYPE / NO. OF MEASUREMENTS:

Without averaging: Each single measurement is displayed.

Linear averaging: Single measurements are added and divided by the number of averages.

Exponential averaging: The measurements are averaged exponentially. The final individual measurements are more heavily weighted.

Peak hold: Highest measurement value is displayed.

OVERLAP: Percentage by which consecutive measurements overlap; If the overlap is 0%, the total measurement time is: number of averages x measurement time; the higher the overlap, the shorter the total measurement time. For the runup / coastdown curve, the number of usable measurements can be increased by selecting a higher overlap.

TIME SYNCHRONOUS AVERAGING (PHASE, ORBIT): In this type of averaging, the time signals of each individual rotation are averaged to reduce non-synchronous components in the signal. The calculated phase values are likewise averaged to increase the stability of the phase vector. The parameters for the phase averaging correspond to the settings under "Average type / Number of measurements" (see above). The number of time synchronous averages is either RPM-dependent, user-defined or unrestricted:

'Auto': Number of averages is a function of the rotational speed*.

'Manual': Number of averages can be entered (max. 254).

'Unrestricted': This average type is generally used for balancing. Each individual measurement is averaged with the preceding individual measurement. The longer the measurement takes, the more stable the final result. The measurement must be stopped using the joystick.

PULSE PER REV. (WITH RPM MEASUREMENT): Number of measurement marks on the shaft or coupling.

ORDER (WITH PHASE, ORBIT, COASTDOWN MEASUREMENT)

Order filter for the harmonic vibration components of the signal. For example, only the signal components of the 1st harmonic are filtered out and displayed by the first order filter. A half order is used for detecting oil whirls in machines with journal bearings.

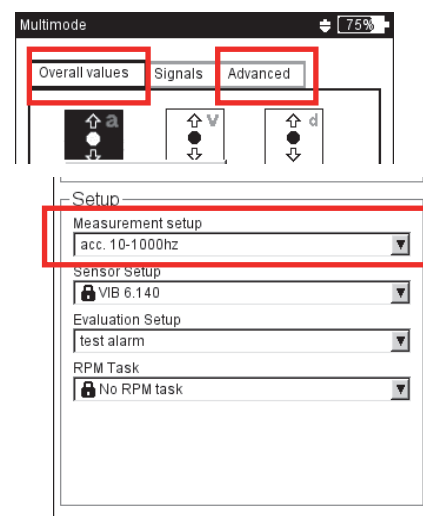

* For example, time synchronous number of averages = 3, if speed \geq 120 rpm.

*'Fixed range', e.g. for a runup / coast-down curve or impact test.

Tip: Carry out a test measurement in order to determine the maximum amplitude.

MEASUREMENT RANGE (ALL VIBRATION MEASUREMENTS): The measurement range for the analog channel (A/B) can be automatically matched to the input signal ('Auto') or set to fixed*. When set to '[Value] / Auto-Up', the measurement range is automatically increased when the upper limit is exceeded.

LOW PASS FILTER (AMPLITUDE COAST-DOWN - PHASE): The low pass filter can be set automatically as a function of the start and stop speeds ('Yes' option). 'No' is used if the low pass filter is not used.

WINDOW / NUMBER OF LINES (IMPACT TEST): The standard window function for the impact test with an impulse hammer is the rectangular window; all other parameters are described in section A2.

NEGATIVE AVERAGING (IMPACT TEST): Enables an impact test while the machine is running (1 channel and 2 channels with impulse hammer). The signals from the running machine are filtered out.

FRF CALCULATION (2-CH IMPACT TEST): Calculation procedure for the *transfer function* - (Frequency Response Function = FRF).

TRIGGER TYPE / LEVEL / START

(SHOCK PULSE, OVERALL VIBRATION VALUE, USER AC, IMPACT TEST)

Level: The measurement starts as soon as the signal has exceeded the selected *trigger threshold* (in % of the max. meas. range). Signal recording can be started before or after the trigger event via the *Trigger start time*.

START / STOP SPEED (RUNUP / COASTDOWN): RPM at which the measurement should start or stop.

RPM DEVIATION (RUNUP/COASTDOWN): Storage condition for the measurement values. The current, averaged measurement value is not saved until the rpm has changed by the value set here.

RPM RANGE (PHASE - CROSS CHANNEL): Maximum RPM range for calculating the phase correlation.

Measurement setup for

- Runup/coastdown analysis (left)
- Orbit (right)

Setup Manager: Measurement

Measurement setup

Overall Coastdown Vel. 1500-300 rpm

Meas. quantity	Velocity
Measurement time	0.500 s
Lower Frequency	10.00 Hz
Upper Frequency	1.00 kHz
Overlap	66.0 %
Measurement range	Auto
Start Speed	1500 rpm
Stop Speed	300 rpm

Setup Manager: Measurement

Measurement setup

Phase Accel.

Meas. quantity	Acceleration
Lower frequency	10.00 Hz
No. of measurements	5
Order	1
Measurement range	Auto
Sensor angle	90 °

SENSOR ANGLE (ORBIT): The angle between the two sensors can be freely selected between 5° and 175°.

DISPLAYED TURNS (ORBIT): The time waveform can be displayed over multiple rotations* to check the phase stability. When the phase is stable, the keyphaser mark in the orbit remains constant.

* up to max. number of averages

A2. Measurement tasks in the 'Signals' tab

MEASUREMENT QUANTITY: see section A1 - 'Overall values' (prev. page).

FILTER TYPE (ENVELOPE): Software / Hardware; envelope calculation using a software algorithm or via a hardware module.

HP/LP FILTER (ENVELOPE)

36-36 kHz; 1-40/ 20/ 10/ 5/ 2,5 kHz (hardware filter)

0.5 / 2.5 / 5 / 10 / 20 / 40 kHz (lowpass (LP) software filter)

Highpass (HP) software filter from 100Hz to LP, freely adjustable

DEMODULATION FACTOR (ENVELOPE): Ratio of the highpass frequency prior to demodulation to the lowpass frequency after demodulation.

LOWER / UPPER FREQUENCY (F_{MIN} / F_{MAX}): Lowest and highest frequency which can appear in the signal. The lower frequency setting of 0.5 Hz or 1 Hz only applies for spectra and overall value measurements. For the 'Displacement' and 'User-defined' measurement quantities, the DC component in the signal can be recorded (lower frequency = DC).

For *envelope spectra* only the 'upper frequency' (f_{max}) is specified.

SAMPLE FREQUENCY (TIMEWAVEFORM): The sample frequency for the time signal defines the maximum, upper frequency.

MEASUREMENT TIME (TIMEWAVEFORM): The length of the time window depends on the sample frequency. The maximum measurement time is 640 s.

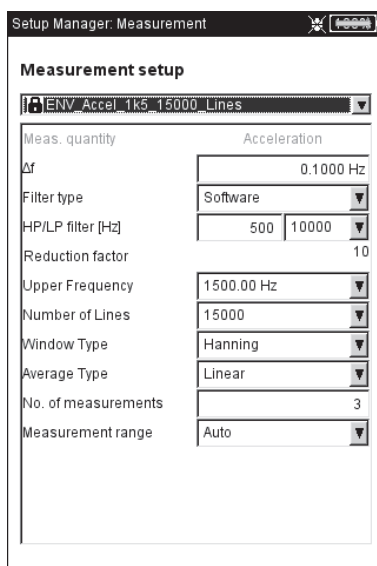
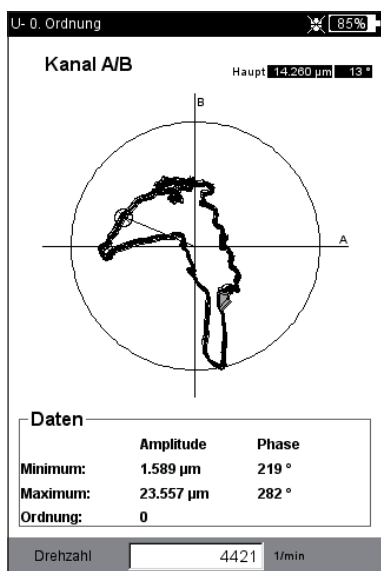
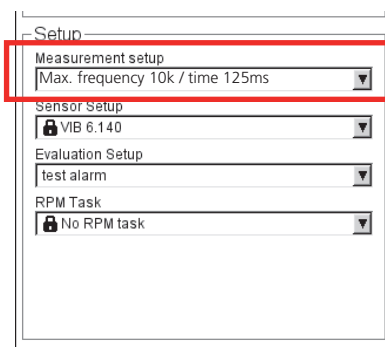
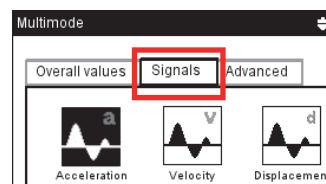

Left:
Keyphaser mark in the orbit remains stable over multiple rotations.

Right:
Setup for envelope spectrum

NUMBER OF LINES (SPECTRUM, CEPSTRUM): Number of lines displayed. Together with the 'upper frequency', this parameter specifies the resolution of the spectrum (Δf).

WINDOW (SPECTRUM, CEPSTRUM): In the measurement of periodic signals, there are time data sets with periodic gaps as a result of the finite observation period. Thus, the frequency lines appear wider in the corresponding spectrum. The window functions suppress these 'side lobes'.



Note

Window features:

Hanning: Standard for FFT. Frequency precise, but amplitude errors (<15%); for the analysis of continuous processes with high frequency resolution and lowest possible leakage effect.

Rectangular: Frequency errors, but amplitude is precise; suitable for the analysis of individual pulses, particularly if the pulse is at the beginning of the time window.

Kaiser: As with Hanning, but lower amplitude errors (<12%)

Flat-Top: Lower frequency accuracy than Hanning, amplitude more precise. For precision amplitude analysis of continuous processes.

Hamming: Frequency errors as in Rectangular; amplitude errors (18%) less than in Rectangular, but higher than in Hanning.

Bartlett: Next to Rectangular, this is the simplest window (triangle); lower amplitude and frequency accuracy.

Blackman: As for Hanning, but with higher frequency accuracy; amplitude errors as in Kaiser (12%); next to Kaiser, the second best alternative for nearly all applications.

AVERAGING TYPE/ NO. OF MEASUREMENTS (SPECTRUM, TIMEWAVEFORM, CEPSTRUM)
Without av.: During the measurement each recorded spectrum is displayed. The 'Number of averages' specifies how many single measurements are carried out.

Linear: The individual spectra are added and divided by the number of averages. This averaging type emphasizes recurring stationary sections in the spectrum.

Peak-hold: Highest measurement value is displayed. This type of averaging emphasizes peaks that occur stochastically.

Exponential: Individual measurements are exponentially averaged (the last spectrum is given the highest weighting).

Time-synchronous: The individual measurements are averaged on an RPM synchronous basis. Reference transducer required.

OVERLAP (SPECTRUM, CEPSTRUM): See section A1.

MEASUREMENT RANGE: See section A1.

TRIGGER TYPE / LEVEL / START (SPECTRUM, CEPSTRUM, TIMEWAVEFORM)
See section A1.

B. Setup parameters for sensors

The transducer parameters to be set up are described on. If you have defined a default transducer for vibration measurements, the 'Sensor Setup' menu is deactivated.

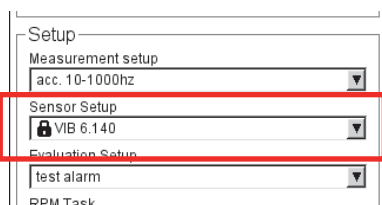

C. Evaluation parameters for overall value / time waveform meas.

Three upper and three lower limits can be defined for each overall value and time waveform respectively (alarm, warning, pre-warning)

- Activate the checkbox in front of the overall value.
- Select the limit value (see below).
- If necessary, change the name.

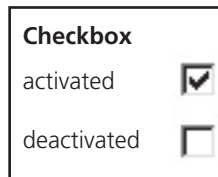

To change the tab, press the '+/-' key or highlight this with the joystick.

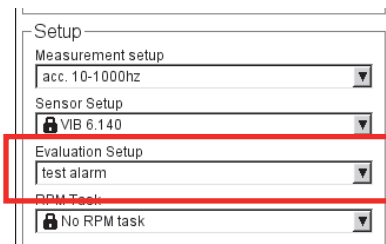

A description can be entered and saved for each user-defined evaluation setup:

- Press the MENU button and click on 'Description'. A text field (initially empty) appears.
- Press the MENU button and click on 'Edit'.
- Enter the descriptive text in the text editor.
- After terminating the text input and closing the text editor, press the MENU button and click on 'Save'.

D. Parameters for RPM measurement

The RPM should always only be recorded if RPM-synchronous signals appear in the spectrum, characteristic frequency needs to be updated, or the frequency axis is scaled in orders (order-based analysis).

If you want to enter the RPM by hand before a measurement, proceed as follows:

- Select the 'RPM measurement' menu and press the MENU key.
- Click on 'Edit'.
- In the 'Sensor Setup' menu, set the transducer to: 'Manual entry'.

Instructions on how to enter the RPM by hand after a measurement (spectrum only) can be found in the next chapter.

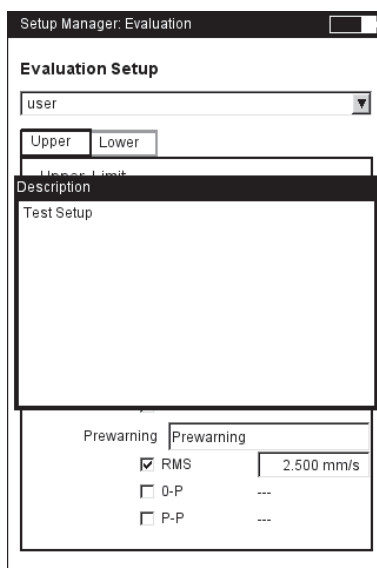
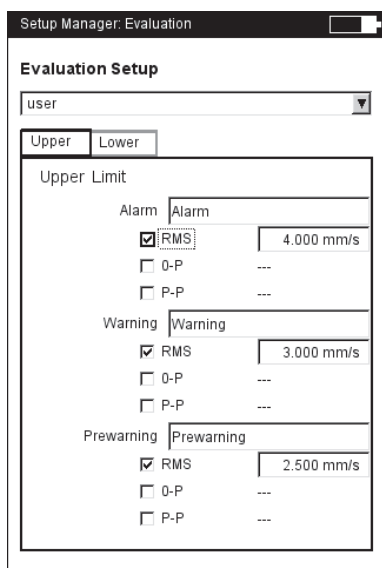
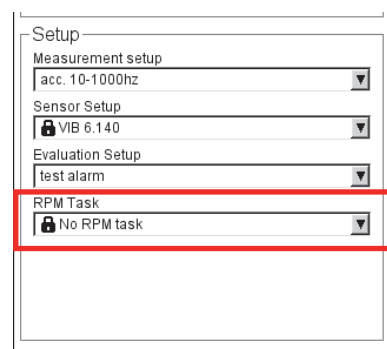

Left: Evaluation parameters for overall values

Right: Evaluation parameters description

* Import user-defined events via OMNI-TREND.

Entering an Event/Comment

You can record information relating to data collection using pre-defined events* and freely editable comments. Up to 10 events can be assigned to every measurement result and every element in a route.

Assigning an event/entering a comment

Prerequisite: The result screen or tree/list view of a route is displayed.

- Press the MENU key and click on 'Event/Comment' (see below). The event editor appears.
- Select the relevant event or events in sequence. The selection is listed in the lower event window.
- To enter a comment, press the MENU key again and click on "Enter comment" (see below). The text editor appears:
Enter the comment and close the text editor. The comment is displayed below the event window.
- To save, press the MENU button and click on 'OK'.



Note

You can edit, delete and add events in the route later on. Events in the 'Multimode' cannot be edited or deleted.



To delete an event/comment in the route

- Press the F key in the event editor to open the bottom event or comment window.
- Select the event or comment to be deleted.
- Press the MENU key and click on 'Delete'.

To find out whether an event/comment exists

- An event/comment icon appears in the result screen next to the channel name.
- An event/comment icon appears in the tree/list view next to the route element.

Left:
Enter comment

Right:
Open Event Editor

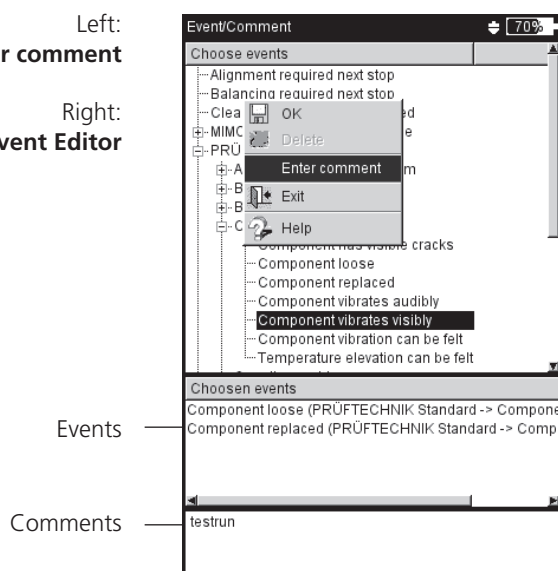

Event / Comment icon

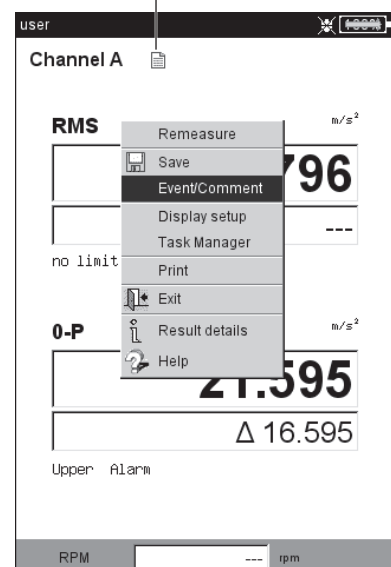

Signal sensitivity on analog output/headphones

The analog output is activated and configured in the device setup. To adjust the sensitivity of the analog output, proceed as follows:

- Press the MENU key in the measurement screen.
- Select 'Analog Out' / '<Sensitivity>' and set the desired sensitivity.

For 2-channel measurements, you can also select the channel whose signal is to be output on the analog output (see below).

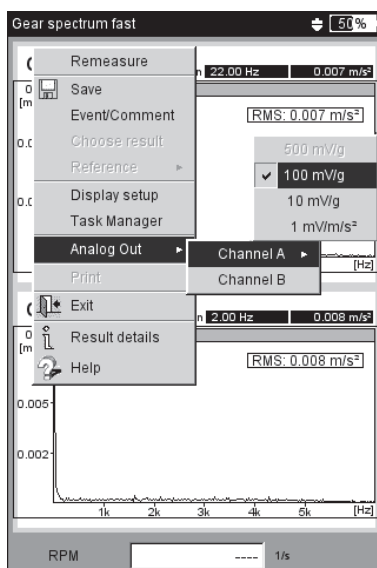

Analog signal output

- Controlling signal sensitivity
- Selecting a measurement channel (2-channel measurement)

Trend

The standard procedure for monitoring machine conditions is the regular recording of characteristic overall values over a longer period of time. The trend of the machine condition can be traced back from the resulting trend curve and its probable development in the future can be predicted.

To obtain a meaningful trend, measurements must be carried out under always reproducible conditions - i.e. operating conditions, measurement location and sensors must be comparable or identical.

In 'Route' mode, you can access historical measurement data and reference data that you can compare to the current measurement data, if necessary.

Trend in a route

- Open the relevant route.
 - Select the measurement task for which at least one measurement has already been saved.
 - Start the measurement.
- After the measurement, confirm the prompt to save which appears. Then* the following message appears (see below):



Tasks already measured!

* When AutoSave is activated, the message appears immediately after the measurement.

APPEND: The current result is added to the saved data set and extends the trend curve (see below).

OVERWRITE: The current result overwrites the already saved measurement data.

- To display the trend curve, highlight the measurement task icon and press the MENU key.
 - Click on 'Display Result'. The progression of the measurement values can be evaluated in the trend screen.
- Prerequisite:* The 'Show result' option in the Route device setup must be set to 'History'.

Left:
Append current result

Right:
Display trend curve

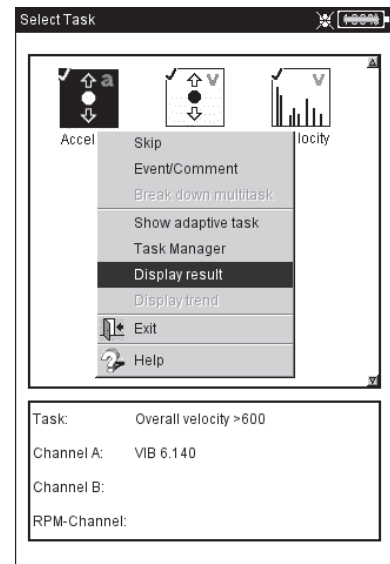
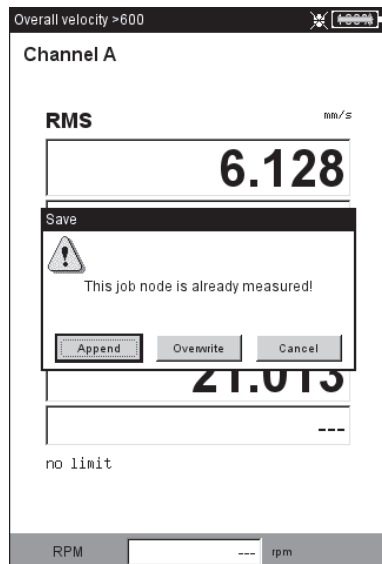

Trend in the 'Multimode'

To start a trend, first open the file in which the measurements that were already carried out are stored:

- Click on 'File manager' in the start screen.
- Click on the file that was saved as a trend measurement.
- To start the measurement, either press the joystick or press the MENU key and click on 'Measure' (see below).
- After the measurement press the MENU button and click on 'Save'.
- In the following prompt, click on 'Append' to add the current result to the saved data record.



To create a new measurement file, select 'New'. This is a simple method of adopting the settings of an existing file for a new measurement.

To overwrite the data of the saved file, select 'Overwrite'.

Measurement data that cannot be displayed as a trend

For measurements such as orbit, impact test, and 1+1 measurement, the results are added to the data set but a trend display is not possible. The individual results can be called up as follows:

- Open the 'File manager'.
- Click on the file with the measurement data.
- Press on the MENU key. Click on 'Select result'.
- Select the desired result in the list (see below).

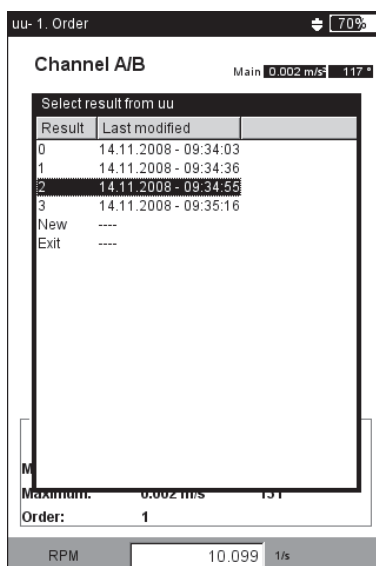
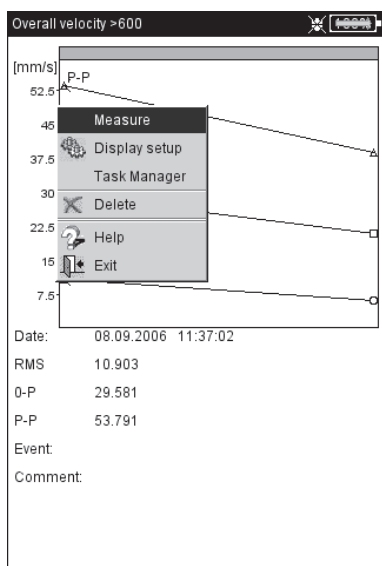

Left:
Starting a trend

Right:
Individual results are listed, if a trend display is not possible.

Comparing the current measurement with historical / reference data

The following requirements must be met to be able to use this feature:

- Historical data for the respective measurement task exist in the OMNITREND database.
- A data set has been declared as a reference in the OMNITREND database.
- The data sets were loaded in VIBXPERT EX with the route.
- The display mode for route results is set to 'Default'.

To compare the current measurement with the reference data, proceed as follows:

- After the measurement is completed*, press the MENU key in the measurement screen.
- Select 'Reference' and click on 'Compare with reference' (see below).

* If the measurement is stored automatically, the program subsequently jumps to the measurement task screen.

Open the current measurement result as follows:

- Highlight the measurement task icon.
- Press the MENU key, and click on 'Display Result' (see previous page).

When overall values are being measured, a value table appears (see below); for signal measurements, the data are displayed in a waterfall diagram.

In a TrendingSpectrum, the display depends on which panel of the results screen is activated: the upper panel containing the spectrum (-> waterfall) or the lower panel containing the characteristic band values (-> trend).

To compare the current measurement with the historical data, proceed as follows:

- After the measurement is completed*, press the MENU key in the measurement screen.
- Select 'Reference' and click on 'Show history'.

When overall values are measured, a trend appears; for signal measurements, the data are displayed in a waterfall diagram.

R: Reference data exist

Left:
Calling up reference data

Right:
Compare current data with reference & historical data
(characteristic values)

The screenshot shows the 'Reference' menu with options: R Compare with reference, H Show history. Below the menu is a table titled 'Reference data'.

	Current	Reference	Unit
RMS	0.070	1.572	mm/s
0-P	0.197	2.645	mm/s
P-P	0.387	5.289	mm/s
Crest	2.818	1.682	mm/s

The screenshot shows a waterfall diagram with the following data:

	Aktuell	Referenz
RMS	4.045	1.572
0-P	6.502	2.645
P-P	13.005	5.289

Datum: 08.08.1998 13:09:50

Ereignis:
Kommentar:

Prewarning if measurement values deviate excessively

In the 'Route' mode, VIBXPRT EX recognizes by how much the current measurement value differs from the last recorded historical measurement value. If this deviation is large, the green LED on the device lights up and the symbol R! appears in the results screen.

For this prewarning to appear, the following requirements must be met:

- The maximum permissible deviation of the measurement values is set in the OMNITREND software (here: 20%).

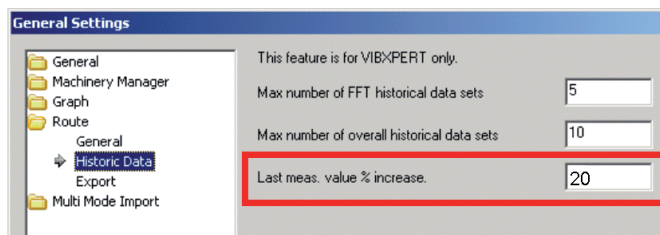

- The '% deviation' and 'Historical data' functions are activated in the OMNITREND Route Editor.

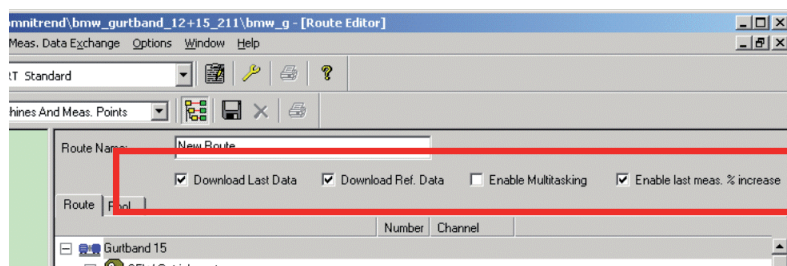

- The information and data sets have been loaded into VIBXPRT EX with the route.
- The display mode for route results is set to 'Standard'.

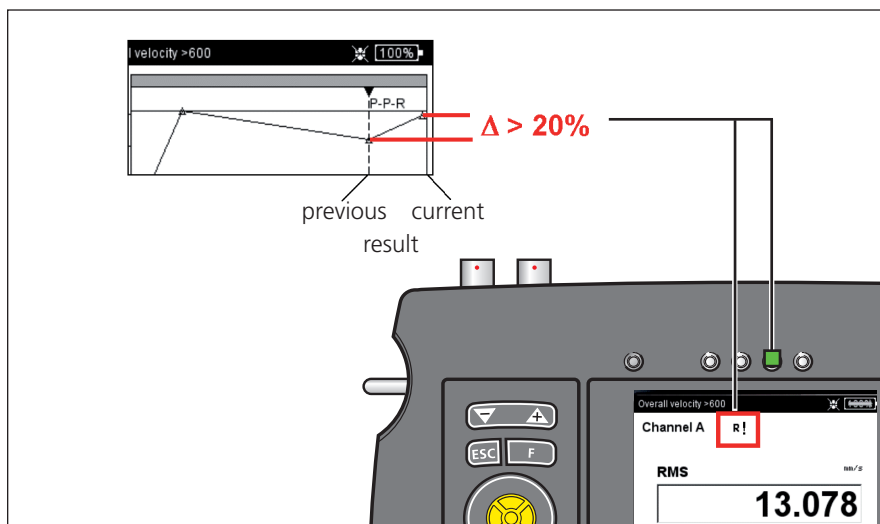

Example:

If the current result deviates from the previous result by more than 20%, the green LED lights up.

Near location (Route)



Data collection on a route progresses more rapidly when measurement tasks at near measurement locations are performed simultaneously. For this purpose, VIBXPert EX and OMNITREND provide the 'Near location' function:

Description

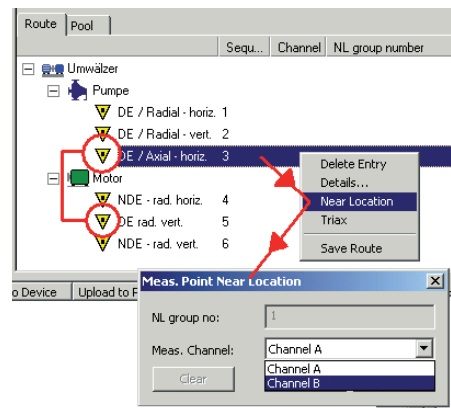
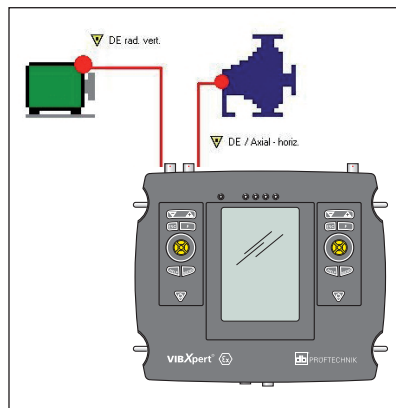
- The measurement channels are assigned and the two measurement locations are spatially allocated when the route is established in OMNITREND:



Near location

-  Icon - channel A
-  Icon - channel B

- In the tree/list view, near measurement locations are labeled with an icon that also indicates the measurement channel for the measurement locations. When a near measurement location is selected, the associated measurement location is automatically highlighted in grey (see below).
- VIBXPert EX always groups two fitting measurement tasks to one 1+1 measurement according to certain rules. Measurement tasks that do not fit this pattern are measured individually in sequence (see below).

Left:
Near location
in the tree view

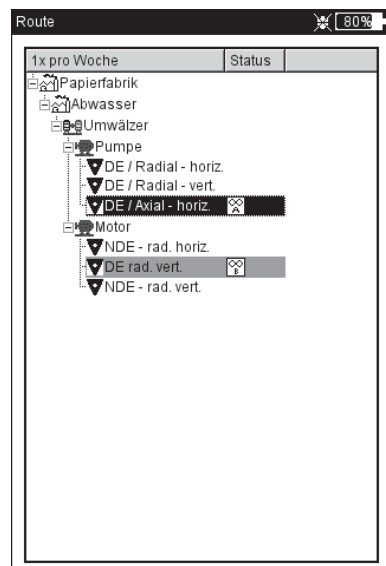

Right:
Fitting measurement tasks are grouped to one 1+1 measurement

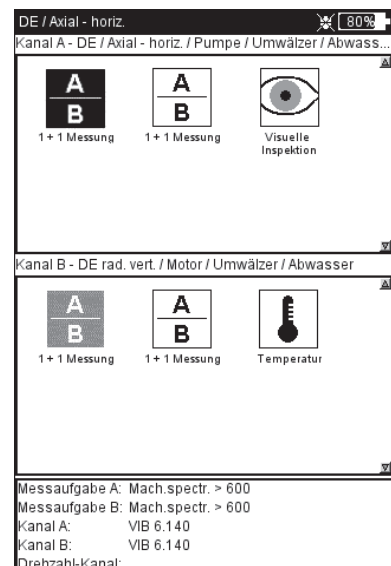

Restrictions

- The grouping of measurement tasks to a 1+1 measurement is only possible if firmware module '2 channels' (VIB 5.381) has been registered in the device.
- For 'Near locations', the "Multitask" measurement task is disabled.
- In the route runtime setup, a standard sensor should not be set up and the measurement channel must be set to 'Auto'.
- Because a trend display is not possible for 1+1 measurements, the last measured result always appears when a result is loaded via the measurement task selection.
- Adaptive measurements are not possible if an overall value task with alarm is defined at both adjacent measurement locations.

Options during the route

Skipping a measurement location/measurement task:

- If you skip over a measurement task, only the grouped measurement task within the 1+1 measurement is skipped.
- If you skip a measurement location, the near location is skipped as well - including all associated measurement tasks.

Disabling the spatial sequence:

This procedure affects the selected route element and the appropriate tasks. This procedure cannot be reversed!

- In the tree/list view, select a route element and press the MENU key.
- Click on 'Break near location' (see below).
All lower level measurement tasks are then performed like normally configured one-channel measurements.

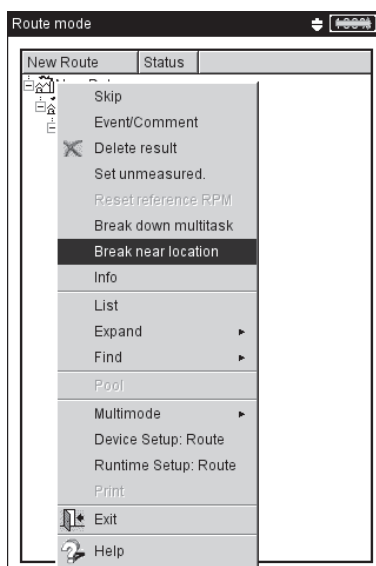

Disabling near location(s)

* Firmware module 'Recording' (VIB 5.385) must be registered.

Recording

With the 'Recording'* function, you can perform measurements dependent on time or rotational speed. For example, this method can be used to record measurement values under certain operating conditions (= rpm range) or at fixed time intervals.

Availability and restrictions

Recording is available in 'Multimode' for every measurement. The following measurements cannot be recorded:

- COASTDOWN CURVE
- IMPACT TEST
- TIME WAVEFORM RECORDER
- PHASE - CROSS CHANNEL
- ALL VIBCODE-MEASUREMENTS

Restrictions also apply to the following measurements:

- SPECTRUM: Averaging is not possible for rpm-controlled recordings.
- TIME WAVEFORM: The 'time synchronous' averaging type is not permissible.
- MULTI MEASUREMENT TASKS: rpm-controlled recording is not possible.
- SHOCK PULSE MEASUREMENT (ROLLER BEARING CONDITION): rpm-controlled recording is only possible without normalization.

Configuration

- Click on 'Multimode' in the start screen.
- Select the measurement for which you want to set up recording.
- Press the MENU key and click on 'Recording' (see below).

Opening the recording configuration window

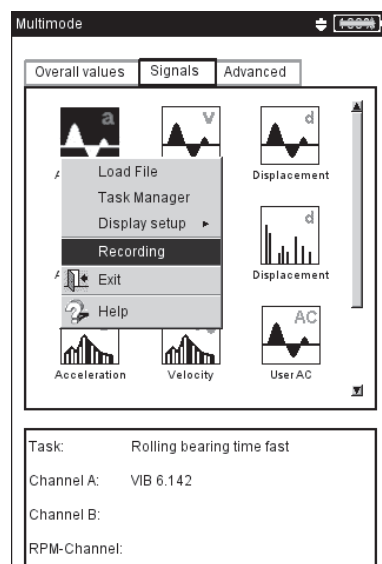

The configuration screen appears (see below):

Start conditions

IMMEDIATELY: The recording starts immediately (MENU -> Start).

START IN: Recording begins after a set period (0 s ... 23:59:59 h).

START AT: The measurement recording begins at the set time (time, date) or when the set rpm is reached (0 ... 1000 Hz); the rising or falling edge can be selected. For an rpm-controlled measurement, the task must contain an rpm measurement.

DELAY: Specifies the time/rpm change between two measurements.

Stop conditions

COUNTER: The measurement is ended when the entered number of results has been measured (1 ... 10000).

RUN FOR: Recording duration (0 s ... 23:59:59 h).

STOP AT: The measurement stops at the specified time or when the set rpm is reached (0 ... 1000 Hz); the rising or falling edge can be selected.

MANUAL: The measurement stops when the memory card is full or when the ESC key is pressed.

Further settings

SWITCH OFF BACKLIGHT: To save power when operating the device during recording, the display illumination can be switched off permanently. This option is independent of the settings in the device setup.

TRIGGER: This option is only available if the measurement is triggered via the signal level.

‘Individual’: The trigger condition is only considered before the first measurement.

‘Multi’: Only start each measurement when the trigger condition has been met.

TARGET FILE: The results and the configuration settings are saved in a file. It is not possible to add multiple recording files.

The start, stop and delay conditions can be independently controlled according to time or rpm. For example, recording can be set to start at a certain time, but the next measurements only take place after a certain change in the rpm.

The screenshot shows the 'Recording' configuration screen with the following settings:

- Start:**
 - Immediatly (selected)
 - Start in: 00:00:00
 - Start at: 04.12.2008 12:53:36
- Delay:**
 - Delay: 00:00:01
- Stop:**
 - Counter: 5 (selected)
 - Run for: 00:00:00
 - Stop at: Time 04.12.2008 12:53:36
 - Manual (selected)
- Info:**
 - Maximum number of results: 24881
- Switch off backlight:**
- Trigger:** Single
- Target file:** recording0

Recording configuration

The number of results depends on the available memory space

Testing the rpm sensor

To test the function and the positioning of the rpm sensor, a test measurement can be performed prior to the measurement recording:

- Press the MENU key and click on 'Test speed'.
- To return to the configuration screen after the test measurement, press the ESC button.

Displaying the characteristic overall values

During the measurement recording, a dialog window appears in the measurement screen with an overview of the configuration settings. Optionally, you can also display a characteristic value overview (see below):

- Press the MENU key in the configuration screen and click on 'Overall overview' (see below).
- Activate the characteristic values to be displayed, and select, if necessary, an additional parameter (maximum, minimum, max./min.). Up to nine values can be displayed at the same time.



To hide the dialog window and display the concealed areas of the measurement screen, press the F key.

Starting the measurement recording

- Press the MENU key in the configuration screen and click on 'Start'.

The measurement screen appears. A dialog is displayed in the foreground that contains the most important information on the recording: start conditions, stop conditions, trigger variable (time or rpm), number of measurement values already recorded (see below).

A sensor test is always performed prior to recording. Exception: the start condition is set to 'Immediately'.

Left:
Measurement value recording
Display of the recording configuration and overall value overview (optional)

Right:
Overall value overview
Configuration

Maximum number of values: 9
(here: 8 values are displayed)

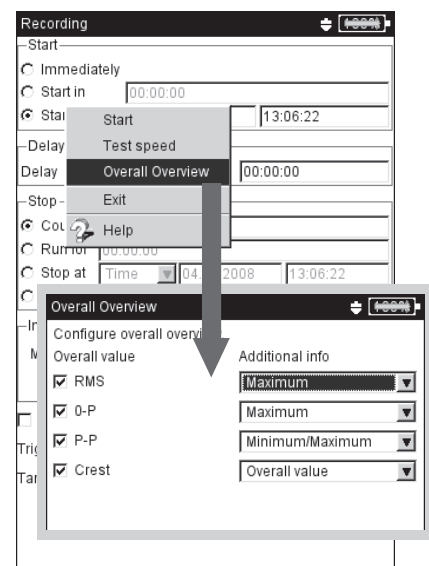
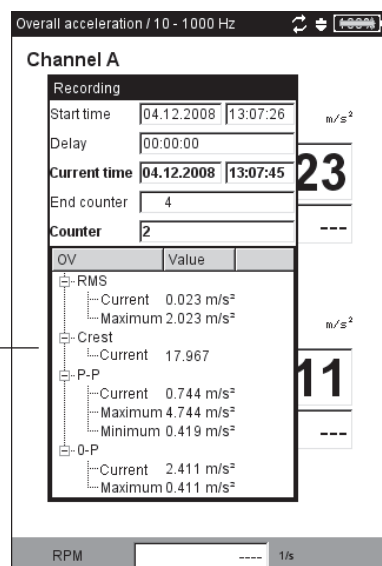

Ending the measurement recording

The measurement recording is ended when

- the stop condition is fulfilled
- the ESC button is pressed
- the memory card is full
- the maximum number of results is reached (65535).

Special cases

The recording function is used in a wide range of applications and is intuitive in use. However, the following special characteristics should be noted:

What happens if the device shuts down due to a fault?

If the battery should run out during measurement, the device saves the measurement data prior to the emergency shut-off. If a fault arises during measurement, the saved results are retained.

Shock pulse measurement

Before beginning recording, enter the normalization parameters. This normalization then applies to the entire measurement duration. Note: rpm-controlled recording is only possible without normalization.

Trending spectrum

To be able to record the measurement values in a trending spectrum, the recording function is also available in the 'Machine template' mode. Recording is configured and started as described in the previous section.

Special characteristics:

- The trending spectrum is integrated in a machine template (OMNI-TREND software).
- In addition to the trending spectrum, the machine template can contain all measurement types permissible for the recording.
- Recording is only possible in the template without a 'Production test'.
- After the recording, all actions that are triggered automatically are disabled in the template (e.g. starting the next task).
- The recording configuration is not saved with the result.
- Multiple datasets can be added to a file.

* Dep. on the sample rate and memory capacity; a 2 GB memory card and a sample rate of 512 Hz can record approx. 132 hours.

Time waveform recorder

The time waveform recorder can be used to record time waveforms over very long* times. In contrast, the maximum recording length for time waveforms using the recording function is approx. 640 seconds (at a 512 Hz scan rate).

The time waveform recorder can be found in 'Multimode' on the 'Special' tab.

- Check the measurement settings in the measurement task manager, especially the settings for the measurement time and scan rate.
- To start the recording, click on the icon shown on the left.
- Then enter the file name under which the result is to be saved.
- Signal recording then begins.

The measurement screen only shows the entire measurement time and when the measurement will be ended. The recording can be stopped at any time using the ESC button. You can save the measurement data that have already been recorded. If the battery is low during recording, the device automatically saves the data.



Note

The data can be read into OMNITREND via Multimode import and then analyzed. Alternatively, they can be read out of the device using the 'VIBXPRT EX utility' service program and imported into a separate analysis software.

Evaluation on device

After the data have been recorded, you can choose to display the signal over one or multiple shaft rotations.

- Press the MENU key and click on 'Postprocessing / Time-synchronous average'.
- Enter the shaft rotational speed.

Left:
Recorded time waveform
in circular plot and cartesian plot

Right:
Screen during recording

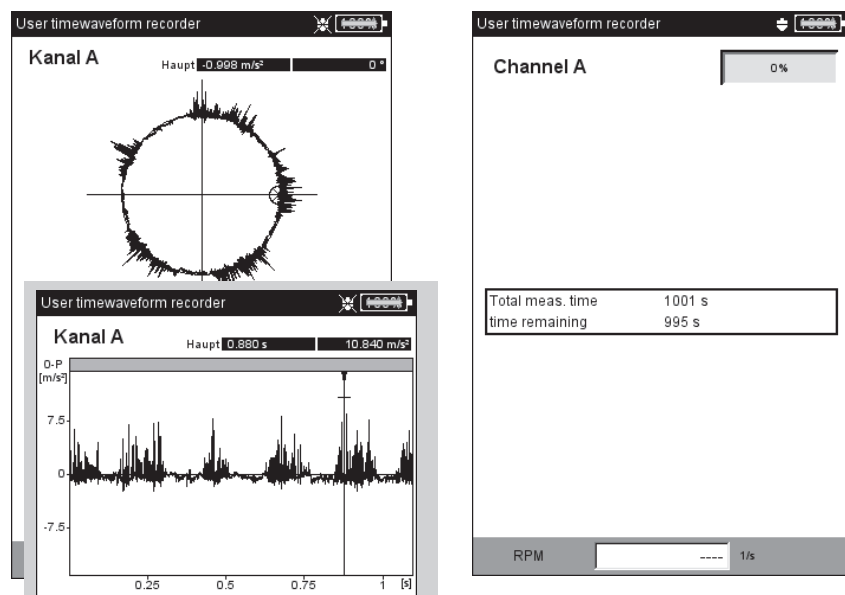

Chapter 4: Results

After each measurement, it is possible to save the results and to evaluate them on the device. Numerous functions that can be called up with the MENU key in the results screen are available for this purpose (see below).



Multimode

Results from the 'Multimode' operating mode can be found in the 'Results' directory in the File Manager. The data are available as individual results, trends or data sets of non-trendable measurements. These data can be accessed at any time on the device even if they have already been transferred to OMNITREND.

Route/template

Results of a route or a machine template are usually stored automatically to speed up the data recording. The results only then remain in the display if ...

- ... the menu is opened within the selected waiting time,
- ... the 'AutoSave' option is deactivated,
- ... a stored result is opened.
- ... the measurement has exceeded a limit value.

To open a result of a route / template measurement, proceed as follows:

- Open the route / template.
- Select the relevant measurement task.
- Press the MENU key and click on 'Display Result'.

The following sections show the options that your VIBXPERT EX provides for evaluating the results on the device.

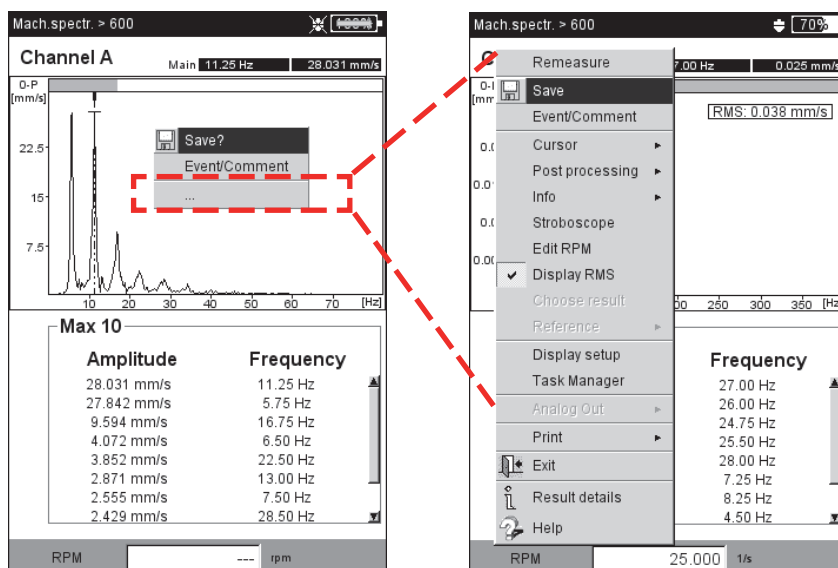

Results screen in the route
with concealed menu.
Click on '...' to open the full menu.

Evaluating results

Before a result is evaluated, make sure that the measurement is valid and no error message is present.

Result details

After a measurement, the following measurement parameters can be displayed (Press MENU and click on 'Result Details'):

MEASUREMENT TASK, MEASUREMENT CHANNEL, MEASUREMENT RANGE, SENSOR TYPE, DATE/TIME, STATUS AND STATISTICAL DATA (FOR OVERALL VALUES ONLY).

Characteristic overall value - single values

Up to two overall values are simultaneously displayed in the result screen. The RPM appears in the lower area. If the limit values are exceeded during the measurement, these appear in the field below the respective measurement value (see below). Also, the respective LED lights up next to the display. Limits can be displayed as an absolute value or as a difference to the measurement value.

For vibration parameters with more than two overall values*, move the joystick upwards or downwards to display the other values.



- * e.g.: Vibration parameters with 6 overall values:
- rms value
 - 0-p value
 - p-p value
 - 0-p calculated (= RMS x $\sqrt{2}$)
 - p-p calculated (= 0-p x 2)
 - Crest factor

Left:
Result screen for overall value

Right:
Result details

RMS value
(no threshold value exceeded)

P-P value
(alarm exceeded by 0.778 m/s²)

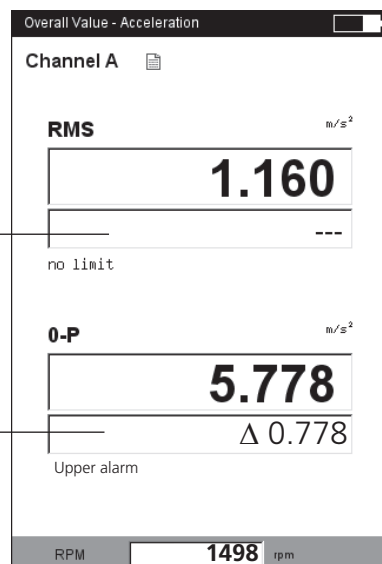

Result details	
Details	Values
Job	Acceleration
Channel	A
Used range	75.000 m/s ²
Sensor Type	LineDrive
Date/Time	08.09.2006 13:05:55
Status	- Alarm
Statistic	
RMS	
MEAS	1.101
MIN	0.248
MAX	1.768
StdDev	0.634
0-P	
MEAS	31.832
MIN	0.510
MAX	48.172
StdDev	22.155
P-P	
MEAS	36.416
MIN	0.962
MAX	54.964
StdDev	25.079
Crest	
MEAS	28.904
MIN	0.000
MAX	0.000
StdDev	0.000

Characteristic overall values - trending

If more than two measurements are saved in a file, the results for each overall value are displayed as a trend curve.

Markers on the trend curve indicate each individual measurement. The measurement values at the cursor position, the date, the rpm if applicable, and assigned events and comments are specified below the diagram. Use the F key to display the individual results.

With the aid of the displayed threshold line, it is possible to determine if thresholds have been exceeded. If more than one overall value appears in the diagram, only the threshold for the highlighted value is displayed (in the below screen: upper alarm for p-p value). Move the joystick up / down to mark the other overall values and display the respective threshold values.

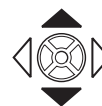

Zoom

Press the '+' button repeatedly to magnify the area around the cursor. This process can be undone again with the 'Minus(-)' key.

The gray bars above a diagram show the displayed range relative to the entire display range.



Deleting individual measurements

If a spurious measurement has been included in the trend, delete this as follows:

- Highlight the measurement in the trend with the cursor.
- Press the MENU button.
- Click on 'Delete'.

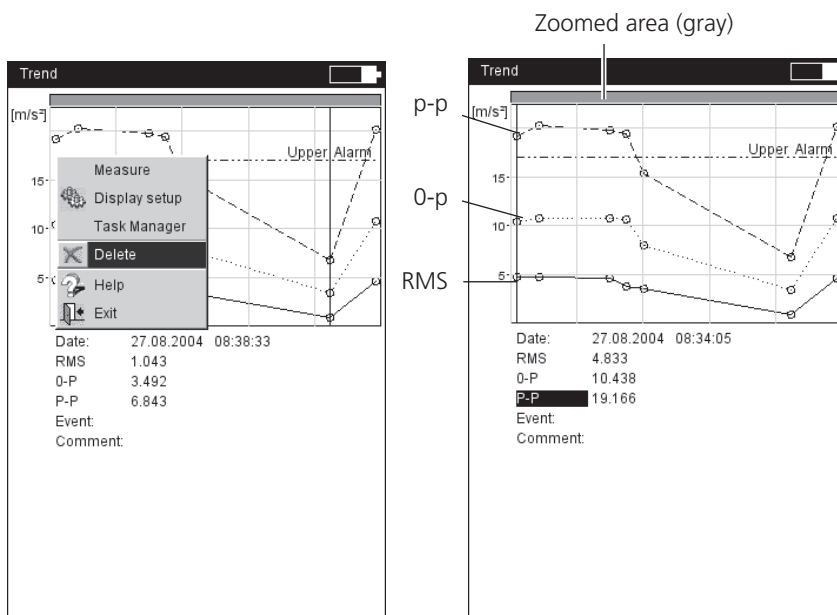

Left:
Delete measurement

Right:
Trend diagram



Time waveform

The measurement results are displayed as an XY diagram in the top section of the window (see the standard setting). The data field in the lower half lists the two highest amplitudes (positive & negative). If a limit value is exceeded, the absolute value and the difference to the measurement value is displayed ('delta', see below).

The following functions are available for evaluation of the result:



Zoom the time (X) axis

- Press on the rocker key '+' to magnify the X axis. Depending on the zoom mode, the main cursor is used as the central point or the gap between the main and delta cursor is magnified. The '-' key is used to zoom out.



Scaling the amplitude (Y axis)

- Move the joystick upwards / downwards to change the scaling of the Y axis.

Rotational speed marker

The yellow rotational speed markers indicate the trigger pulses during signal measurement. In the circular plot, the speed markers also indicate the direction of rotation (see the next page).

Cursor

The cursor coordinates are displayed in the black fields above the diagram.

- Press the MENU key and click on 'Cursor'.

NONE: Hide all cursors (Zoom / scaling not possible!)

MAIN: Show main cursor

Move the joystick towards right/left to move the cursor. The speed increases if the joystick is held in an extreme position.

Zoomed area (gray) Cursor coordinates

Result screen of a time waveform measurement

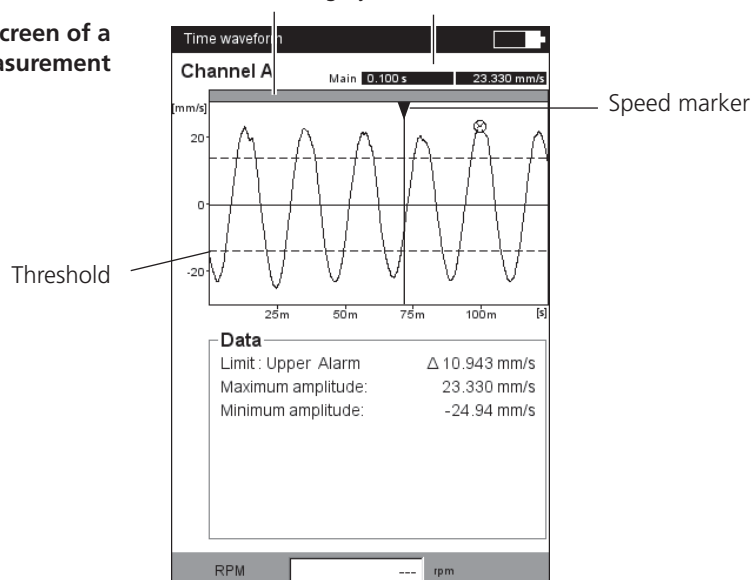

DELTA: Show/hide delta cursor

Press the joystick (ENTER) to switch over between main and delta cursor. In this case the measurement can only be repeated via the MENU key (MENU - 'Remeasure')!

The cursor coordinates indicate the distance to the main cursor.

The data field specifies the frequency which corresponds to the distance between the main and delta cursor (see below).

SIDEBANDS: Show/hide sideband cursor

Select the number of sidebands. The spacing of the sidebands is set by moving the outer cursor*. The position of the entire group can be changed by moving the middle (main) cursor.

* press the joystick to switch between the main and the outer cursor.

Cartesian / circular plot

By default, the time waveform is displayed in a Cartesian plot (XY diagram). However, you can change the display to a circular plot. This is useful when the gear mesh in a gear stage is to be emphasized, for example. In this type of display, the measured time interval is projected on a circle, so that the start and end times are directly adjacent to one another. If the shaft rotates by 360° within the measured time interval, the circular diagram shows the signal for one complete rotation of the shaft.

- Press the F key to toggle the two diagram types (see below).

**Signal post processing****Calculating the characteristic overall values**

The following overall values can be calculated from the time waveform:

- Maximum / minimum amplitude,
- Arithmetic mean, p-p value, RMS value, Crest factor.

- Press the MENU key in the result screen.
- Select 'Post-processing' and click on 'Compute overall values'.

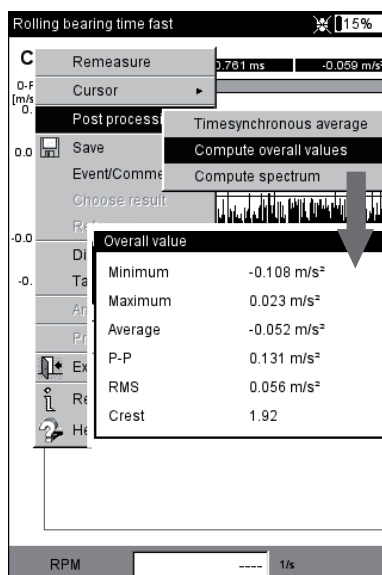
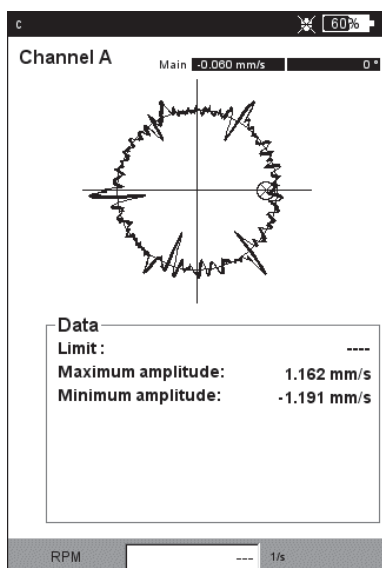

Left:
Time signal in circular plot

Right:
Signal postprocessing

Calculating the spectrum

Based on the time signal, you can calculate a spectrum that you can save and measure again.

- Press the MENU key in the result screen.
 - Select 'Post-processing' and click on 'Compute spectrum'.
 - Set the parameters in the lower window pane (see below):
- Input signal
ENTIRE SIGNAL: the entire signal is used to calculate the spectrum.
VISIBLE SIGNAL: the spectrum is based only on the visible signal.
Zoom the display if required*.
 - MAIN TO DELTA: Move the cursor to set the interval.
START AT MAIN: only the signal from the main cursor is being used.
 - Averaging mode: Single shot / Averaging
 - Window type: Select the appropriate window type.
- Press the MENU key and click on OK.

* Press the F key to switch between the upper and the lower window pane.



The calculated spectrum can be saved and measured again. A transformation is only possible in the Cartesian display.

Displaying the rpm run

If the rpm is recorded alongside the time waveform, you can display the rpm run as follows:

- Press the MENU button in the result screen.
 - Select 'Post-processing' and click on 'Compute rpm signal'.
- The rpm run appears in the bottom section of the window.

Left:
Calculating the spectrum
from the time waveform

Right:
RPM run during
signal measurement

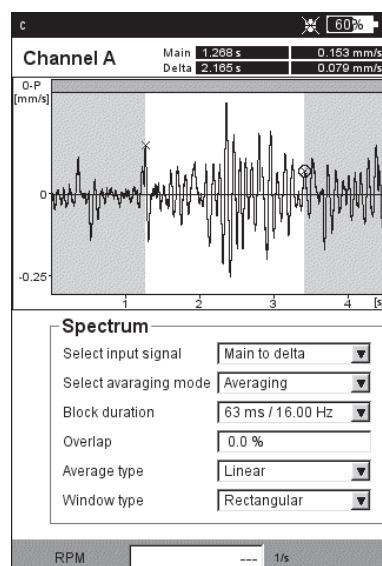

Speed marker

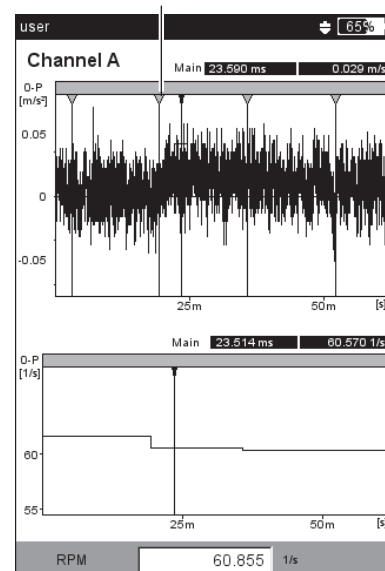

Time-synchronous average (Post-processing)

If a trigger signal is recorded in addition to the time signal, further information can be obtained.

For example, the time signal can be determined synchronously with every rotation of the shaft. In this way, events in the signal that are synchronous with the RPM are emphasized and stochastic results are suppressed.

If the measurement locations are on a gearbox, the time signals can be determined for one rotation using the transmission ratio of the gearbox.

- Press the MENU key.
- Select 'Post-processing' and click on 'Time-synchronous average':
- If you measured the RPM simultaneously with a trigger sensor, activate the 'Trigger' option and enter the number of 'Revolutions' per trigger pulse. Using the 'Start with trigger' option, you can synchronize the time signal using the trigger pulse.
- If there is no trigger signal, you can simulate it by using a manually entered RPM value. In this case, the trigger options described above are deactivated. The RPM value (in Hz) corresponds to a block length in the time signal described by the relationship $f = 1/t$.
- In the 'Revolutions' field, you can compensate for any differences in RPM between the trigger measurement location and the signal measurement location (e.g. the translation ratio in the gearbox).

Close Post-processing

- Press the MENU button in the result screen.
- Select 'Post-processing' and click on 'Data'.

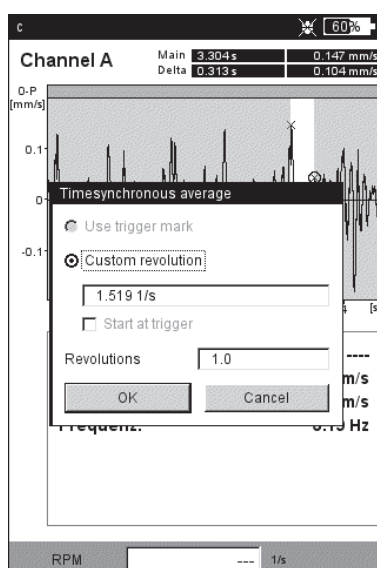
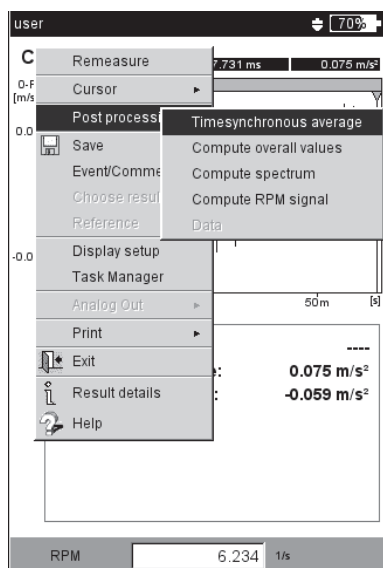

Time-synchronous average: Configuration

Results



Spectrum: Amplitude, Envelope , Order



Trending, TrendingEnvelope , Cepstrum

In-depth information is given in the section 'Measurement Tasks' (Ch. 5).

Spectrum, Cepstrum

The measurement result is displayed in the upper half of the screen. The measured time signal is displayed in the lower half of the screen during the measurement. After the measurement, the following information can be displayed after the measurement:

- Max 10 (10 highest amplitudes in the spectrum)
- Alarms
- Frequency marker (only in Route / Template mode)
- Trending parameters (only in TrendingSpectrum)
- Time signal measured
- Position of the main cursor

- Press the MENU key and select the 'Info' option.
- Click on the desired piece of information:



Note



The data to be displayed by default after the measurement is set in the display setup.

The active window pane is highlighted by a frame. Press the F key to switch to the other window pane.

Max 10

Lists the 10 highest amplitudes in the spectrum. Click on an entry to set the cursor to the corresponding line of the spectrum. You can sort the list for amplitude or frequency in ascending or descending sequence. To do so, click on the respective column title.

Left: **Spectrum & time waveform**

Right: **Additional information**

lower display field is active

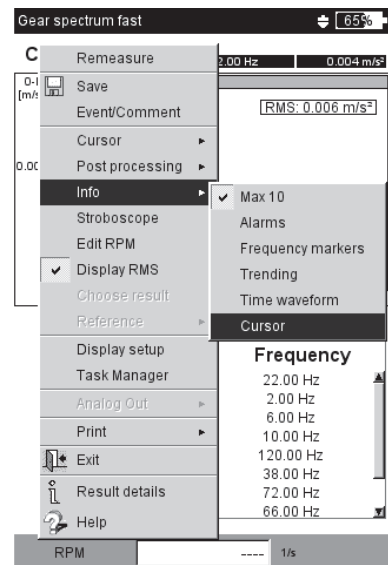
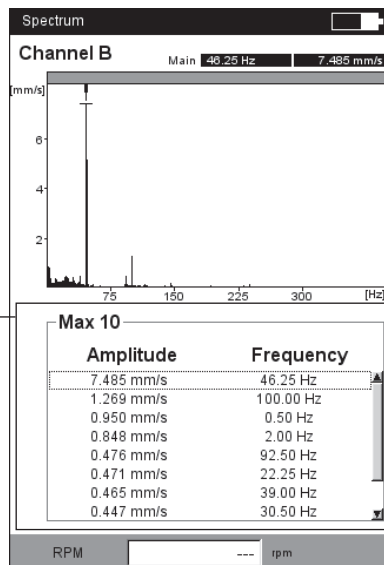

Alarms

This function checks if a threshold value was exceeded. If so, one of the LEDs lights up.

To display the thresholds in the spectrum,...

- Press the F key to activate the lower window pane.
- Select the corresponding checkbox in the tree view.



Frequency marker

Frequency markers can be used to more easily identify the characteristic machine and component frequencies in a spectrum. Frequency markers are defined for each machine hierarchy level* in the OMNI-TREND software and loaded into VIBXPERT EX with a route / template.

- Press the F key to activate the lower window pane.
- To display the frequency markers of each single hierarchy level, press the MENU key and select from the list (see below). Frequency markers from lower hierarchies are added to higher hierarchies (meas. loc. -> machine -> machine train).
- Activate the corresponding checkbox in the tree view.

For RPM-dependent frequency markers (e.g. Imbalance -1st harmonic), the machine RPM must be known - either by manual entry or by measurement.



Note

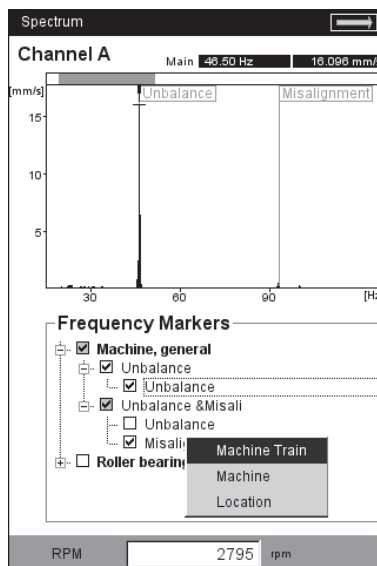
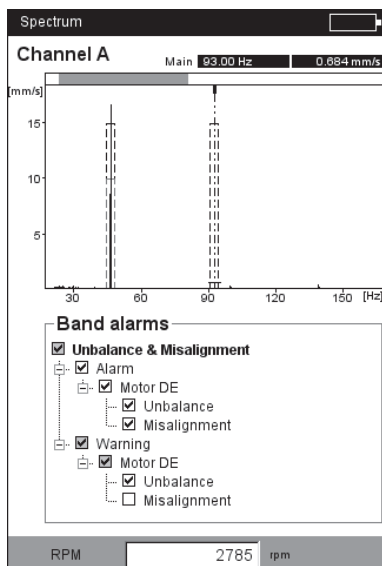

Left:
Narrowband thresholds
(‘Band alarms’)

Right:
Frequency marker

Trending values (in the TrendingSpectrum only)

A TrendingSpectrum contains, in addition to the time signal and the corresponding spectrum, up to 30 characteristic overall values. The overall values are formed using frequency bands that are set up in the OMNITREND PC software.

The following trending parameters are provided in the lower pane:

- Name and current trending value,
- Limits of the frequency band ('Start' / 'End'),
- Measurement type (e.g. 'True 0-peak'),
- Measurement variable (e.g. 'Velocity') and, if applicable, threshold values ('Alarm level').

Comparing trending values with historical / reference values:

- Activate the lower window pane using the F key.
- Press the MENU key and click on 'Show history'.
A table appears that contains the trending values, the current measurement values and - if set up - the reference values.
- Select the trending values that are to be compared.
- Press the MENU key and click on 'History'.
A diagram appears in which the historical and current measurement values are visible as a trend.



Time waveform

The measured acceleration signal can be shown in the lower pane for test purposes. Only the Zoom function is available for signal evaluation.

Cursor

Enable the 'Cursor' option when working with the harmonic/subharmonic cursor or with the sideband cursor and if you would like to display the coordinates of each individual cursor.

Left:
TrendingSpectrum
(Trending values are given in the lower window pane)

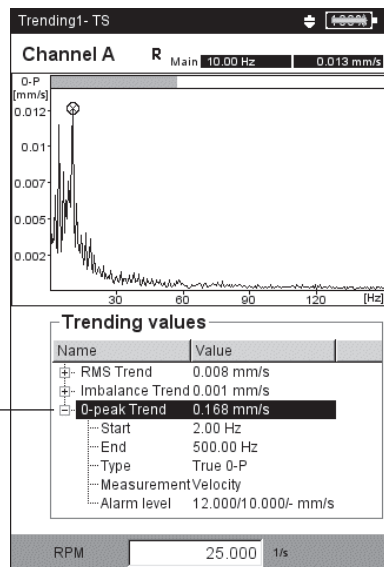

Right:
Comparing trending values
with Reference / Historic data

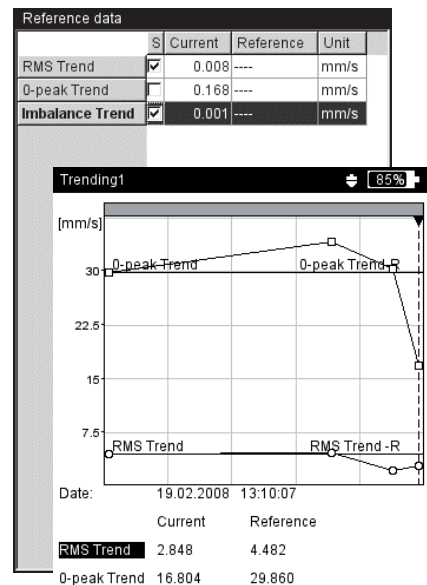

Trending value

The following functions can be called up directly in the MENU:

Stroboscope

This option is not functional in VIBXPRT EX.

RPM edit

To enter the machine RPM after a measurement, press the MENU key and click on 'RPM Edit'. Enter the RPM value in the number editor.

Display RMS

This function calculates the RMS value of the spectrum and shows it on the graph (see below).

Post-Processing

Each spectrum is initially calculated from the measured signal and then integrated to convert it to the desired measurement quantity*. Post-processing is provided as an option for subsequently altering the measurement quantity in the spectrum and for converting a velocity spectrum into a displacement spectrum , for example.

* velocity, displacement

The 'Alarms' diagnosis function is only available if the spectrum is displayed in the original measurement quantity.

Reference (only in the route / machine template mode)

Here you can compare the current spectrum with a reference spectrum or a historical spectrum. The spectra are displayed in a 'water-fall' diagram.

Zoom / Scaling See 'Time signal'

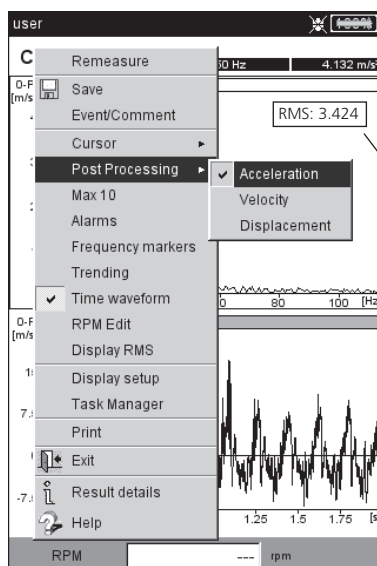

Post processing
(select meas. quantity)

RMS value

Cursor

- Press the MENU key and click on 'Cursor' (see below)

NONE /MAIN / DELTA: See 'Time signal'.

HARMONICS: Show/hide harmonic cursor

The harmonic cursor is used to assign harmonics in the spectrum. The spacing of the individual cursors to one another corresponds to the basic frequency at the main cursor. To adjust this, the main or the delta cursor (highest displayed order) can be moved.

- Adjust the required number of cursors.

SUBHARMONICS: Show/hide subharmonic cursor

The subharmonic cursor can be used to detect subharmonics in the spectrum. The spacing of the individual cursors to one another corresponds to a integer fraction (1/n) of the main cursor.

- Adjust the required number of cursors.



Note

If the subharmonic cursor is activated, the delta cursor is not active.

SIDEBANDS: Show/hide sideband cursor

The sideband cursor can be used to identify modulations of a carrier frequency. The distance of the sidebands can be set by moving the outer cursor (press the joystick to change over). Change the carrier frequency by moving the main cursor.

- Adjust the required number of cursors.

Left:
Spectrum, Cursor menu

Right:
Spectrum, Harmonic cursor

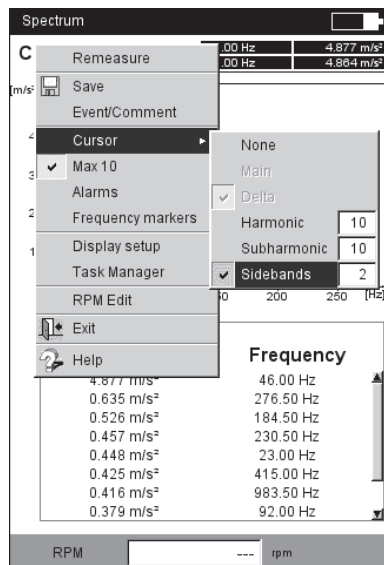

Main cursor Delta cursor
(2nd order)

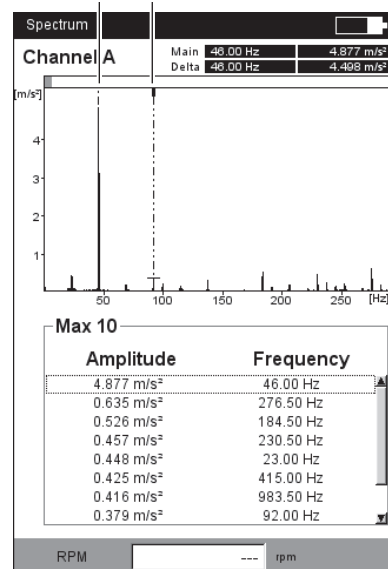

3D display of spectra: Waterfall diagram

If several spectra were recorded for one measurement task (max. 75), these appear in a 3-dimensional diagram - the waterfall diagram.

Navigation



Navigate through the individual spectra.



Move the cursor along the frequency axis.

Change view

To rotate the waterfall diagram change the display mode:

- Press the MENU key and click on 'Adapt Display Field'. Use the joystick to do the following:



tilt the diagram around the frequency axis.



rotate the diagram around the amplitude axis.

This display mode is indicated on the upper left of the diagram by a coordinate icon (see below).



Cursor

Only the main and delta cursors are available for evaluation in the 3-D view. To activate the delta cursor, press the MENU key and click on 'Cursor > Delta'.

Zoom

The Zoom function can be used in the Waterfall diagram along the frequency axis (=X) as well as along the Z-axis. The amplitude axis (=Y) cannot be scaled in the 3-D view.

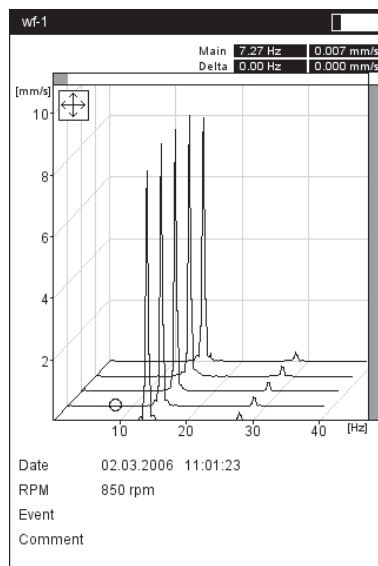
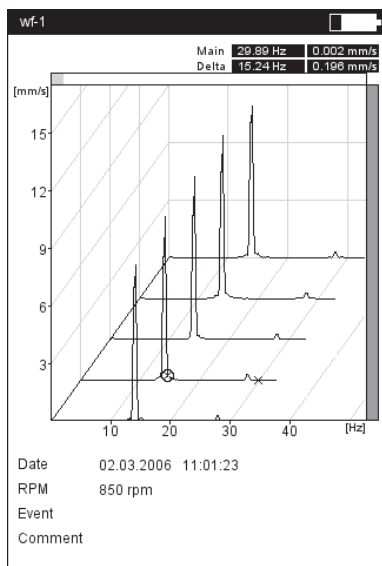

Left:
Waterfall diagram

Right:
Rotate / Tilt diagram:
Use the navigation keys in the  mode



Which of the two axes (X or Z) can be zoomed with the '+/-' key is displayed by a flashing gray bar along the edge. If the right bar flashes, the Z-axis can be zoomed; if the upper bar flashes, the X-axis can be zoomed.

To change the active axis, press the MENU key and click on 'Zoom > X-axis' or 'Zoom > Z-axis'.

Evaluating individual spectra (2D view)

For the evaluation of an individual spectrum, proceed as follows:



- Highlight the relevant spectrum with the cursor.
- Press the F key to display the individual spectrum.
Alternative: Press the MENU key and click on 'Details'.
- Call up the respective diagnosis functions with the MENU key.

To return to the 3D view again, press the MENU key and click on 'Waterfall'.

Zoom

Zoom in on the frequency (X) axis:
upper bar flashes

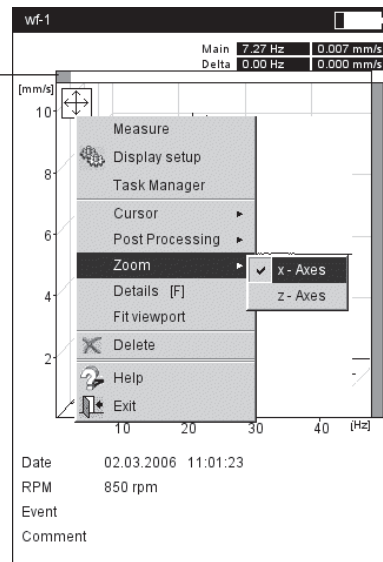

Configuring the result display (Display Setup)

In the Results display, after a measurement:

- Press the MENU key and click on 'Display Setup'.

In the selection field of the measurement tasks (Multimode):

- Highlight the measurement task symbol.
- Press the MENU key and highlight the 'Display Setup' entry.
- Move the joystick to the right and click on 'Measurement' or 'Trend' respectively (s. below).

X. Continuous measurement ('live mode')

In 'Live mode', you can check the signal quality before beginning with data collection.

A1. Display Setup for measurement: Overall values

DISPLAY LIMIT AS...: The limit values can be displayed as an absolute value or as a difference ('Delta value') to the measurement value.

DISPLAY OVERALL PEAK VALUE: Select the characteristic vibration value that is to be displayed by default with the 'RMS value'. After the measurement, move the joystick repeatedly upwards to display the overall values of the series that were not displayed. If the threshold is exceeded, the RMS values and the overall value that exceeded the threshold by the largest amount are displayed.

A2. Display-Setup for Trend: Overall values

MEAS. VALUE: Selection of *overall values*. The *line type* can be selected and the *labeling* can be shown for each trend curve.

SHOW...: *Limits, event markers, references* and the associated *labeling* can be displayed in the chart. The *line type* can be selected.

ZOOM: Speed or step size when zooming

LAYOUT: The values on the trend curve can be identified with *markers*.

A *grid* can be displayed for easier evaluation of the data and the cursor can be displayed as a cross (*short*) or line cursor (*long*).

Display Setup for overall values (more than two overall values)

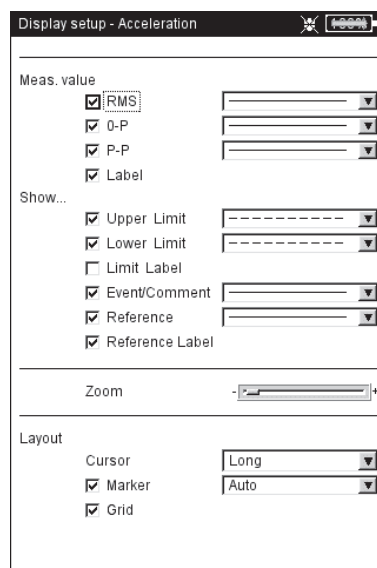
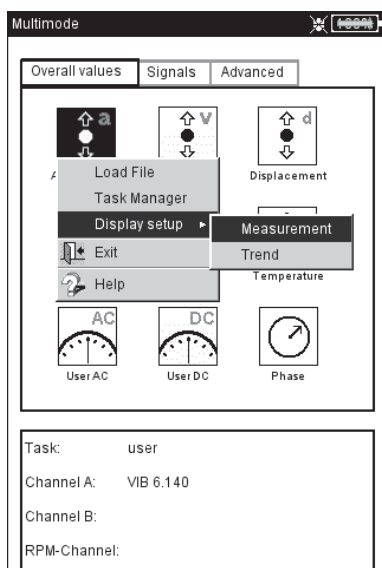

Left:

Opening the Display Setup
before a multimode measurement

Right:

Display Setup for Overall Trend

B1. Display Setup for measurement: Spectrum / Time waveform

ZOOM: Step size when zooming the *X and Y-axis*.

Zoom Mode: The zoom is made around the main cursor or the gap between the delta and main cursor.

CURSOR: Short cursor or line cursor (*long*); *line type* for the line cursor.

DIAGRAM TYPE: A spectrum can be displayed in a *curve diagram* or a *bar chart*. A time signal can be displayed in Cartesian coordinates (*X-Y diagram*) or on a *circular plot*. When taking measurements with DC coupling, the DC component in the signal can be hidden (Option: 'AC only').

SUFFIX FOR 1/1000 OR 1000: Instead of '1/1000' or '1000', the X-axis can be labeled with the abbreviation 'm' (milli) or 'k' (kilo).

AMPLITUDE (SPECTRUM): Amplitudes in *RMS* or peak values (*0-peak, peak-peak*). RMS value of entire spectrum.

ORDER DISPLAY (SPECTRUM): Scaling of the X-axis in Hz (*No*) or orders (*Yes*). The shaft RPM must be known (measured or entered).

AMPLITUDE SCALING (SPECTRUM): linear or logarithmic (in decibels).

DEFAULT DISPLAY MODE (SPECTRUM): Information that appears in the lower display field by default (*Max 10, time waveform, band alarms, frequency marker, trending parameters, cursor coordinates*).

SPEED MARKER (TIME SIGNAL): Display of the trigger signals in the diagram. In the circular diagram, the arrow indicates the direction of rotation.

CONTINUOUS MEASUREMENT (LIVE MODE): see section X.

B2. Display Setup for Trend: Spectrum (Waterfall diagram)

CURSOR & AMPLITUDE: s. section B1; in a waterfall diagram, a *grid* can be superimposed for easier evaluation of the data.

Left:
Display setup for time waveform

Right:
Display setup for spectrum

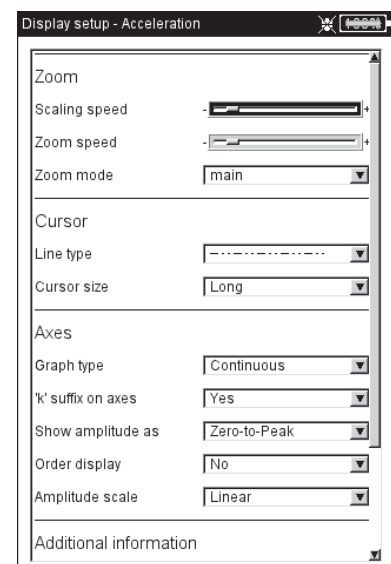
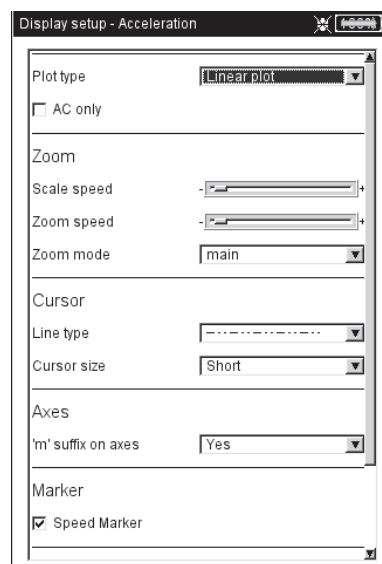

C1. Display Setup for measurement: Coastdown, Orbit, Phase

The following sections C and D only describe the parameters specific to the measurement type. Global display parameters, such as 'Zoom' and 'Cursor', can be found in sections A and B.

SHOW OVERALL (COASTDOWN - OVERALL VALUE): The results screen displays two diagrams, RMS value and peak value in dependence on the RPM. Select the peak value which is to be displayed as standard.

PLOT TYPE (COASTDOWN - PHASE): The runup / coastdown curve can be displayed as a *Bode or Nyquist plot*. *Orbit* (polar representation) and *single signals* (Cartesian representation) can be selected for the shaft movement. The *AC only* option shows the AC component of the signal.

SHOW AMPLITUDE AS (COASTDOWN CURVE - PHASE VECTOR): Amplitudes can be displayed as an RMS value or a peak value (*0-p*).

CONTINUOUS PHASE (COASTDOWN - PHASE WITH BODE PLOT): The scale of the phase axis begins at 0° and ends at 360° . If the curve runs beyond the 360° mark during the measurement, it is continued unchanged at 0° (*No*). If you select the *Yes* option, the phase axis continues beyond 360° - beginning again at 0° - and the phase progression is continually displayed.

SPEED MARKER (ORBIT): See section B1.

ANGLE DIRECTION (COASTDOWN CURVE - PHASE VECTOR, PHASE MEASUREMENT): This parameter is primarily used in displaying the coastdown curve in the Bode plot and determines the direction of rotation of the phase measurement. Select whether the phase should be displayed *before* or *after* the trigger mark.

ANGLE TYPE (COASTDOWN - PHASE, PHASE MEASUREMENT): The angle type indicates whether the *synchronous phase* is measured or whether the phase is displayed in the *mathematically* correct sense.

CONTINUOUS MEASUREMENT (LIVE MODE): see section X.

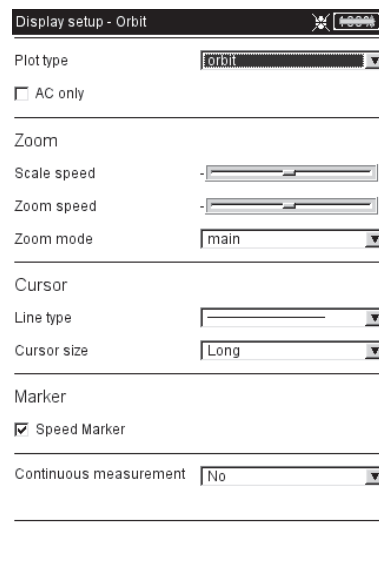
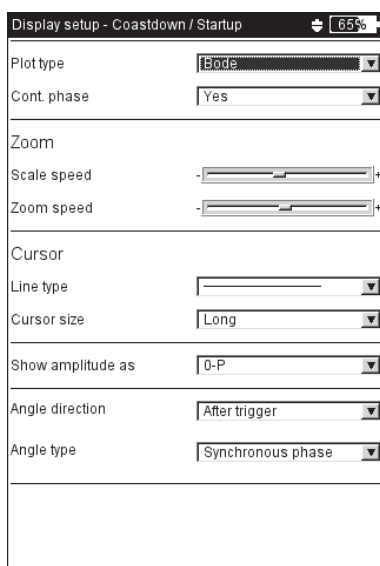

Left:

Display setup for Coastdown
(Phase-RPM)

Right:

Display setup for shaft vibration
(Orbit)

C2. Display setup for trend: phase

PHASE OVER...: When several phase measurements are saved in one file, the phase vectors can be shown depending on the time or rpm (see below).



Phase trend diagram

Use the F-key to open a menu in the results screen (see below) with the following options:

DETAILS: Show result of a single measurement
 NYQUIST / BODE: Change diagram type
 SHOW CHANNEL: Show channel A, channel B or both channels.

D. Display setup for measurement: 2-channel measurement (1+1)

SPECTRUM DISPLAY: If the measurement task contains a spectrum measurement, you can choose whether only the *spectrum*, or also the set *additional infos* (max. 10, time waveform,.. see section B1) should be displayed.

DISPLAY SETUP CHANNEL A / B: Click on *Show* to display the display settings of the individual measurement tasks.

To edit the display settings of the individual measurement tasks, enable the required window section in the measurement screen and call up the display setup via the MENU key.

E. Display setup for measurement: impact test

BUMP DISPLAY: Choose whether the result of the impact test should be displayed as a *time waveform* or *spectrum*.

SELECT RESULT AFTER SAVE: The result selection dialog window opens automatically (*yes*) after a measurement is stored.

Left:
Phase trend
 Phase vector as a function
 of the rpm (see figure) or the time

Right:
2-channel display setup for
 1+1 measurement
 Impact test

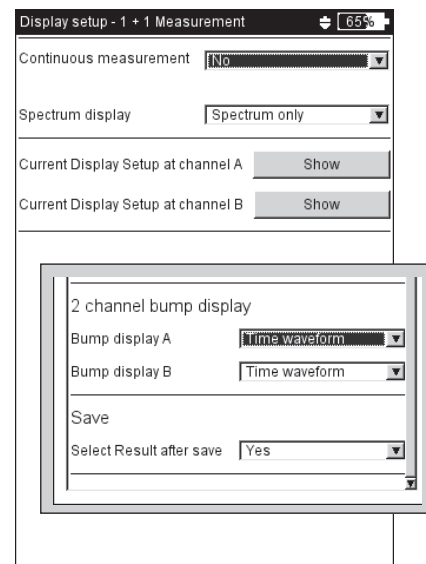
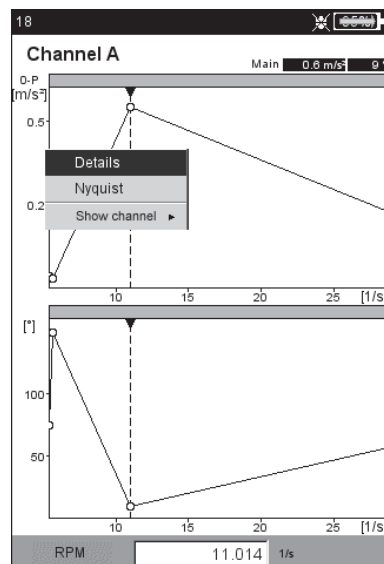

Printing out reports

The print function in VIBXPRT EX enables printouts of the following reports:

- Screenshots
- Measurement reports
- Route / template reports

To be able to print directly on a printer, you require:

- A printer with USB connection
- Universal communication adapter, VIB 5.330UNV

Preparations

- Connect VIBXPRT EX to the printer.
- Set up the printer in the VIBXPRT EX device setup.
- Print out the results (see the following sections)

Printing the screen content of a measurement

- In the result screen, press the MENU key.
- Click on 'Print', or select 'Print' / 'Screenshot'* (see below left). The printer selection dialog window appears.
- Select the printer.
- Press the MENU key and click on 'Print' (see below right). If you select 'PDF' as the printer, enter a file name in the text editor. The printer icon appears at the top edge of the screen while the print job is being processed. The screen printout is scaled to half the page width and is positioned in the middle of the page.

* Only for measurements for which measurement reports are available (see next page)

Measurement reports

A measurement report is used to create detailed documentation on a measurement. The report contains the results, general information on the operator and additional measurement information. Measurement reports are available for the following measurements:

SPECTRUM, TIME WAVEFORM, OVERALL VALUES TREND, TRENDINGSPECTRUM, BALANCING.

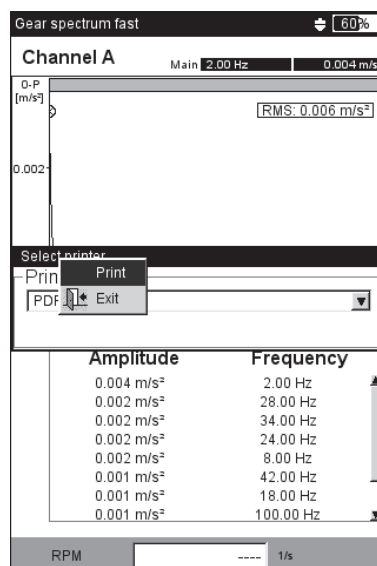
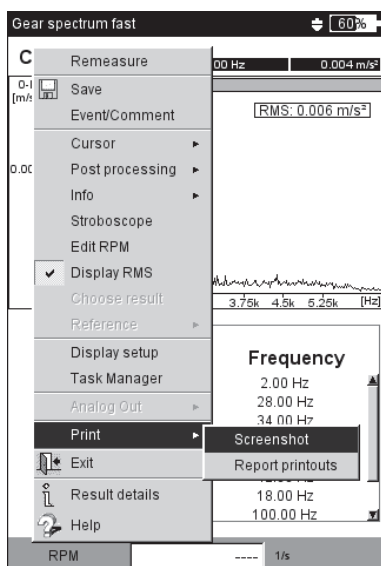

Left:
Print screenshot

Right:
Selecting the printer and start printing.

Configuring the measurement report

Which information is contained in the measurement report is defined in the report configuration. Every measurement has a standard report configuration that is adequate for most cases. The standard configuration can be neither edited nor deleted. To create a new report configuration, proceed as follows:

- Press the MENU key in the result screen.
- Select 'Print' and click on 'Measurement report'.
The report configuration appears (see below).
- Select the 'Reports' field.
- Press the MENU key and click on 'New'.
- Enter a name in the text editor.
- In the 'Common settings' tab, select the entries that are to appear in the measurement report:

COMPANY: Company name that appears on the report. To change it, click on the text field. The changed company name is used in all report configurations.

LOGO: Company logo that is printed in the report. Transfer the new logo using the 'VIBPERT utility' program. File format: PNG, image size: max. 200 x 200 pixels.

CUSTOMER: The customer information is stored globally and can be accessed by any report configuration. Select the customer from the menu, or create a new customer as follows:

- Open the customer selection menu and click on the lowest entry, <Edit>. The customer list appears.
- Press the MENU key and click on 'New'.
- Enter the customer data in the text editor.

INSPECTOR/ASSET: Information on the inspector/asset. Click in the corresponding text field to edit the information.

RESULT FILE NAME: The result file name appears in the report.

Left:
Report configuration
General information

Right:
Report configuration
Information on the spectrum specific to the measurement type

Report selection

Printer: PDF

Reports: Spectrum Report

Common settings | Measure info

Company: Prüftechnik Condition Monito...

Logo: pruftechnik

Customer: xxxxx

Inspector:

Asset:

Result filename:

Report event:

Result event:

Setup info: Standard

Report selection

Printer: PDF

Reports: Spectrum Report

Common settings | Measure info

Max10

Alarms

Timewaveform

Cursor

RMS

REPORT EVENT: Report-specific event. Click in the text field to open the event editor and select the event.

RESULT EVENT: The result-specific events are assigned and stored during measurement. Here you can only set whether or not they should print.

SETUP INFO: Information on the measurement settings to be used. Three options are available for selection:

- *Standard:* The name of the measurement and sensor setup is printed.
 - *Standard + evaluation:* Like *Standard*, plus evaluation setup or machine setup*.
 - *Details:* Like *Standard + evaluation*, plus a screen printout of each setup.
- In the 'Measure info' tab, select the measurement type information that is to appear in the measurement report (compare example on previous page).

* only for balancing reports

Printing out the measurement report

- Select the printer and the report configuration ('Printer' or 'Reports' field).
 - Press the MENU key.
 - Click on 'Print' (see below).
- If you select 'PDF' as the printer, enter a file name.

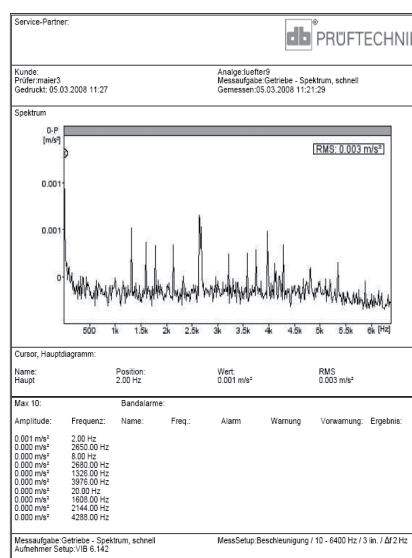
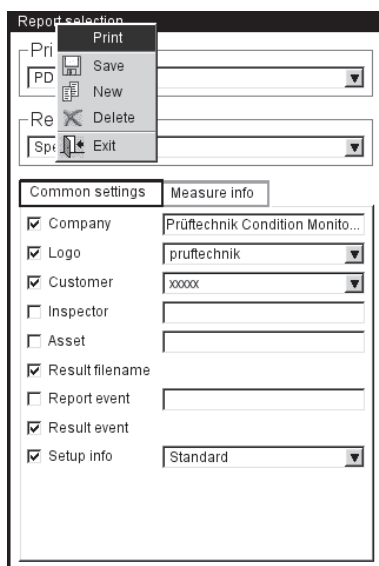

Left:
Printing out the measurement report

Right:
Measurement report for the spectrum

Printing out the report for route/machine template

You can print out the following measurements as reports to document the results in a route/machine template:

ALL OVERALL VALUES, TREND PARAMETERS FROM TRENDINGSPECTRUM, VISUAL INSPECTION, ALL PHASE MEASUREMENTS

In addition to a table of results, the report contains general information and additional data on the measurement. Threshold values are automatically added if they are exceeded during measurement.

- Open the route/template.
- In the tree view, mark the entry for which you wish to create the report.
The results of all measurement locations located below this entry in the hierarchy are printed out.
- Press the MENU key and click on 'Print'. The report configuration appears.
- If necessary, change the report configuration.
The settings in the 'Common settings' tab are the same as the settings for the measurement reports (see previous page). The following detailed data can be set in the 'Measure info' tab.

UNMEASURED JOBS: Measurement tasks that have not been measured are included in the report.

RPM: The speed is printed out if available.

CAPTION: A legend is output as an appendix to the report.

OVERALL VALUE: Selection of the vibration values

TABLE ORIENTATION: Arrangement of the measurement tasks in the table (*horizontal/vertical*).

PAPER ORIENTATION: Paper orientation selectable between portrait or landscape.

Start the printout as described under 'Printing out the measurement report' (see previous page).

Configuration for route report Specific data

Report selection

Printer: PDF

Reports: u

Common settings | Measure info

Unmeasured jobs

RPM

Appendix

Overall value

RMS

0-P

P-P

Crest

Table orientation: horizontal

Paper orientation: Portrait

Chapter 5: Measurement tasks

This chapter contains information on the individual measurement tasks and tips for carrying out a measurement.

The '2-Channel Measurements' module must be registered if you want to measure on both channels.



Note

Characteristic overall vibration values

Characteristic overall vibration values are used for evaluating machine, bearing and gear conditions. A good indicator of the vibration forces acting on a machine is the effective value (RMS) of the vibration velocity in the frequency range 10 - 1000 Hz or 2 - 1000 Hz. Evaluation criteria of the permissible vibration levels are specified in the ISO 10816-3 norm (see below). These ranges are preprogrammed in VIBXPRT in the form of threshold values and can be accessed in the Evaluation Setup.

As well as the effective value of the vibration, VIBXPRT EX records the highest signal amplitudes as peak values (0-peak, peak-peak) and calculates the crest factor from these.

What is the crest factor?

The 'Crest Factor' is the ratio of the highest amplitude to the effective value (RMS) of a vibration and is a measure of the intensity of the impacts in the form of a vibration. Among other things, the crest factor is deployed for wear diagnosis in roller bearings and gearing mechanisms as well as for cavitation. A harmonic vibration of amplitude '1' has 0.707 as its effective value and a crest factor of 1.41. If the crest factor is higher than 1.41, impacts with higher amplitudes are occurring.

Overall vibration values



acceleration



velocity



displacement

ISO 10816-3 for the assessment of machine vibrations

To assess the machine condition, the machine is first assigned a machine class with the aid of the lower axis. The range in which the measured effective value falls can be read from the axis at the side.

What you need to do:
 Range A: Continue to measure at regular intervals.
 Ranges B,C: Look for the cause of the vibration. Observe the machine closely. Schedule a power down.
 Range D: Take immediate measures: Localize the cause, switch the machine off and remedy the problem.

D					11	0,43
					7,1	0,28
C					4,5	0,18
					3,5	0,14
B					2,8	0,11
					2,3	0,09
A					1,4	0,06
					0,71	0,03
					mm/s	inch/s
	rigid	soft	rigid	soft	Foundation	
	med. sized mach. 15 kW<P≤300 kW		large machines 300 kW<P<50 MW			
	Motors 160≤H<315 mm		Motors 315 mm ≤ H		Machine type	
	Group 2		Group 1		Group	



The procedures used for bearing diagnosis (shock pulse, envelope curve, vibration acceleration) comply with the ISO norm, 10816-1 (Appendix E3 , E1).

Shock pulse measurement

Shock pulse signal levels are indicated as a combination of 'Carpet value' (background level, indicative of lubrication condition) and 'Maximum value' (transient peak level, indicative of damage), both expressed in logarithmic [dB] terms. Bearing condition is determined by comparing normalized signal levels and their difference with reference values.

These characteristic overall values are typically affected by various external factors (e.g. rolling velocity, i.e. bearing size and rpm, signal damping, lubrication). To evaluate the condition of the bearing objectively and to allow comparison between values measured on different bearings requires either a comparison measurement in the good condition or a normalization of the measured values.

Normalization

This process considers the following individual factors:

- Bearing size, RPM

These bearing-specific factors are combined in the so-called 'initial value' or the 'dBi value'. The dBi value is calculated from the rotational speed and the bore diameter of the bearing.

- Signal damping, lubrication, load, ...

These unspecific external influencing factors must be determined empirically within the framework of a 'normalization adjustment'. Together with the dBi value, the 'adjustment value' obtained in this way, or even the dBa value, results in the so-called 'adjusted initial value' (dBia value).

Consequently, the normalized shock pulse value (dBn) works out to:

$$\underline{dBn} = dBsv - dBi - dBa = \underline{dBsv - dBia} ,$$

where dBsv = non normalized shock pulse value

Normalization adjustment

Under ideal conditions (dBa=0), the normalized carpet value of a bearing in good condition equals 5 dBn. The 'true' dBa value equals the difference from the measured value, only with the initial value (dBi) normalized carpet value.

Example

Normalized measurement on a new bearing: 9 dBn.

The adjustment value is therefore:

$$9 \text{ dBn} - 5 \text{ dBn} = 4 \text{ dBa.}$$

Entering the normalization parameters

Before the shock pulse measurement starts, the normalization screen appears:

- Select the type of normalization:
 NO NORMALIZATION: Shock pulse value specified in dBsv.
 MANUAL: RPM is entered manually before the shock pulse measurement.
 EXTERNAL: RPM is measured with an RPM sensor before the shock pulse measurement.
- Enter the dBa value in the number editor if it is known. Otherwise, carry out a normalization adaptation (set dBa to '0', see previous section).
- Enter the diameter of the bearing inner race.
- If the normalization type is set to 'manual', enter the RPM (see below).
- To start the shock pulse measurement, click on 'OK'.

Shock Pulse meas.

Channel A

Normalization Mode

Select normalization mode

No normalization

manual

external

dBa

Diameter

RPM

dBia

RPM [1/min]

Shock pulse - Normalization



RPM measurements

Machine speed (rpm) is measured using the laser trigger sensor (VIB 6.631 EX). The sensor works with red laser light that is emitted from the sensor head. The bundled laser beam hits a measurement mark on a rotating shaft and is reflected back with every rotation. Every time the trigger optics detect the light reflection, the sensor emits an electrical impulse. The device uses the rate of occurrence of the voltage pulses to calculate the shaft speed*.

* If shaft speed $< 0,1$ Hz (= 6 rpm), then change the 'Keyphaser - Timeout' setting in the Device setup.



Laser trigger sensor (VIB 6.631 EX)

Typical installation for a vibration measurement with simultaneous recording of the rotational speed.

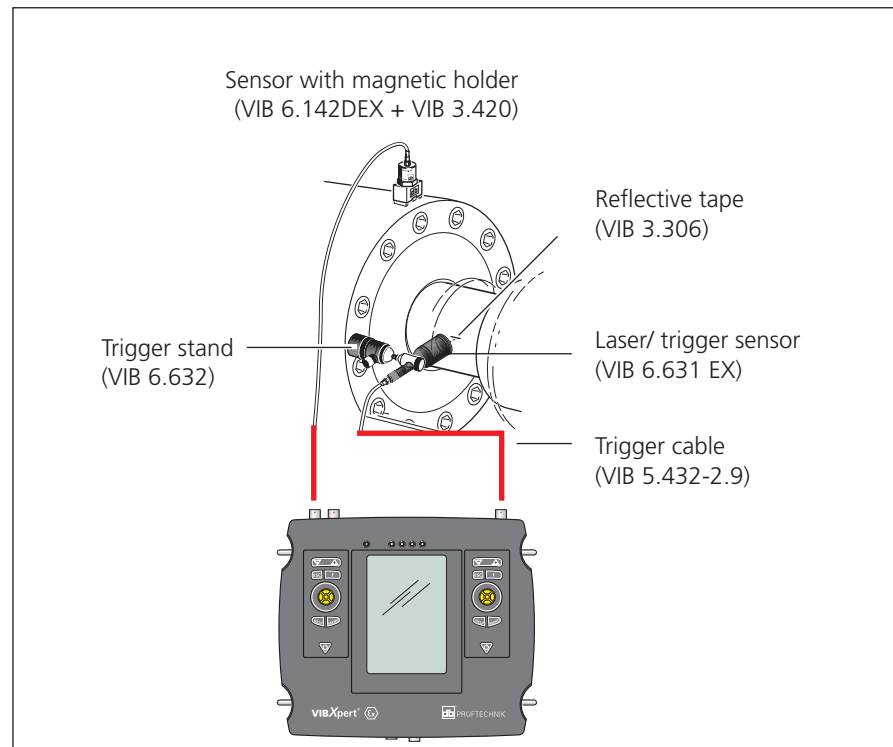

Temperature measurement

For temperature measurements thermocouple type K sensors such as the VIB 8.608 handheld probe or the VIB 8.607-1.5 sensor with magnetic holder can be used.

Tips for measuring

- Hold the sensor at the measurement location until the sensor has recorded the temperature of the measurement object.
- If the values vary, repeat the measurement or increase the number of averages in the measurement setup.
- VIBXPERT EX does not carry out any sensor detection on the measurement channel for temperature. If the results are not correct, check the connection and the sensor cable.



Measurement range:

VIB 8.608: -50°C to 500°C

VIB 8.607: -50°C to 240°C

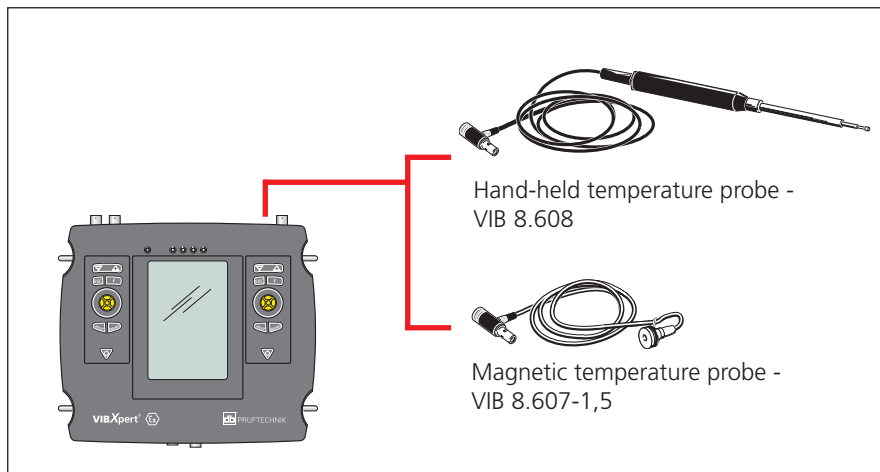

Type K thermocouple

Runup / Coastdown

The runup and coastdown curves record the changes in the vibration behavior of the machine when it starts up or shuts down. This analysis function can be used to determine the resonance frequencies of a machine. The following types of measurement are available for this purpose:

- Phase vector (amplitude and angle), dependent on the RPM
- Spectrum, dependent on the RPM
- Overall value, dependent on the RPM

Runup

Measurement is started *before* the machine is switched on. VIBXPRT EX records the current RPM and automatically begins with measurement as soon as the selected start RPM is exceeded. Measurement is stopped when the stop RPM is reached.

Coastdown

Measurement is started *while* the machine is running at the operating RPM. VIBXPRT EX then begins to measure the RPM continuously. Once you have switched the machine off and it drops below the selected start RPM, VIBXPRT EX automatically starts recording the data. Measurement stops once the selected stop RPM is reached. Start and stop RPMs are defined in the measurement setup.

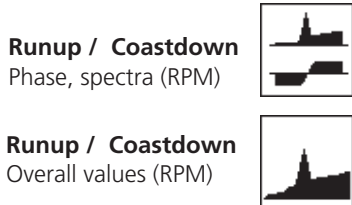

A. Selecting the measurement task

The measurement tasks for a runup / coastdown curve are located in the 'Advanced' tab. The measurement types 'Phase - RPM' and 'Spectra - RPM' are assigned a task icon; the 'Overall Value - RPM' measurement type has its own icon.

Left:
Selecting the measurement task

Right:
Starting the measurement
Overall value - RPM

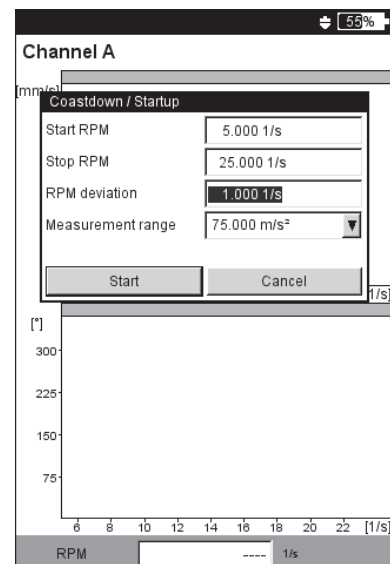
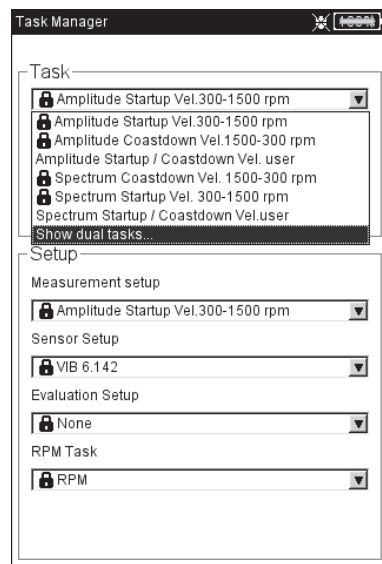

A.1 Selecting the measurement task via the measurement task icon:

- Highlight the respective icon in the 'Advanced' tab.
- Press the F key to display the stored measurement tasks
- Select the required measurement task using the identifier.
The identifiers of the measurement tasks set up in the factory can help in selection:
 - DUAL or 2-C: 2-channel measurements
 - SPEC or SPECTRUM: 'Spectrum RPM' measurement type
 - OVERALL VALUE: 'Overall Value - RPM' measurement type
 - STARTUP: Runup
 - COASTDOWN: Coastdown



A.2 Selecting the measurement task in the Task Manager:

- Highlight the respective icon in the 'Advanced' tab.
- Press the MENU key and click on 'Task Manager'.
- Click in the uppermost menu to display the stored measurement tasks. The 'Show Dual Tasks' or 'Show Single Tasks' menu entries display the available 2-channel or 1-channel measurement tasks (see below)
- Select the desired measurement task.
- Select the desired measurement task.

B. Starting the measurement

- Click on the measurement task icon.
A dialog window appears in the measurement screen in which you can temporarily change the following setup parameters:
 - START RPM, STOP RPM
 - RPM DEVIATION
 - MEASUREMENT RANGE.
- Click on 'Start' after the parameters have been set correctly.
During data collection, the relevant measurement data are displayed in a dialog window (see below).

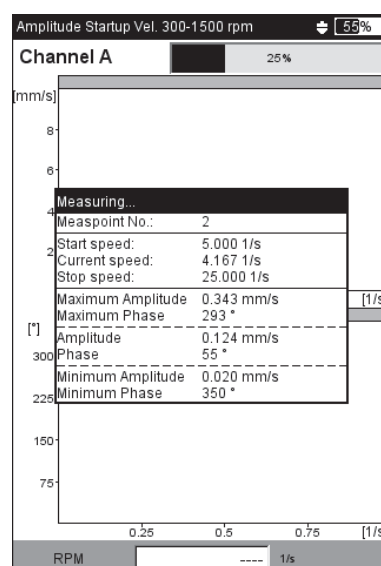
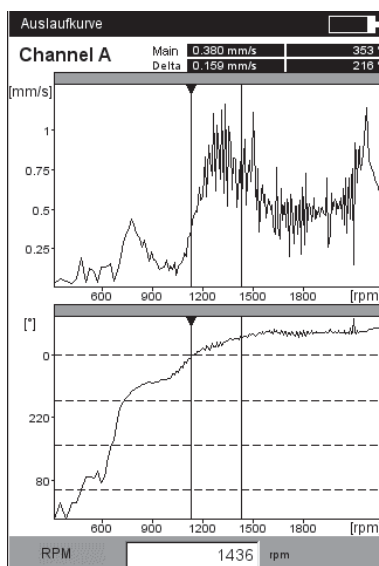

Left:

Runup / Coastdown
Phase - RPM (Bode plot)

Right:

Results screen during a coastdown measurement
Phase - RPM

C. Supplementary information

C.1 'Overall Value - RPM' measurement type



This type of measurement records the progression of the characteristic overall vibration values relative to the RPM. Points of resonance are indicated by RPMs with increased vibration amplitudes.

The Results screen displays the path of the RMS value in the upper diagram; one of the three peak values (0-p, p-p, crest factor) can be displayed in the lower diagram:



- To do this, press the F key and select the respective characteristic value (see below).

C.2 'Spectrum - RPM' measurement type



This type of measurement records the spectra while the machine RPM is changing. In this way, the progression of the RPM-dependent vibration components in the spectrum can be tracked and the points of resonance can be identified.

To start the measurement, the following condition must be fulfilled:

$$f_{max} \geq 4x n_{max} \text{ (maximum rpm)}$$

The results screen always displays two consecutive spectra of the recorded series (see below). Use the '+/-' key to scroll forwards and backwards. The current number and the associated RPM for the spectrum are displayed at the top left of the diagram. To scroll in only one of the two diagrams, fix the display in the other diagram:

- Press the MENU key and click on 'Lock graph > lock lower (or) lock upper'.

A better overview is provided by displaying the spectra in a waterfall diagram:

- Press the MENU button and click on 'Waterfall diagram'.

Runup / Coastdown:

Overall value - RPM
selecting peak value

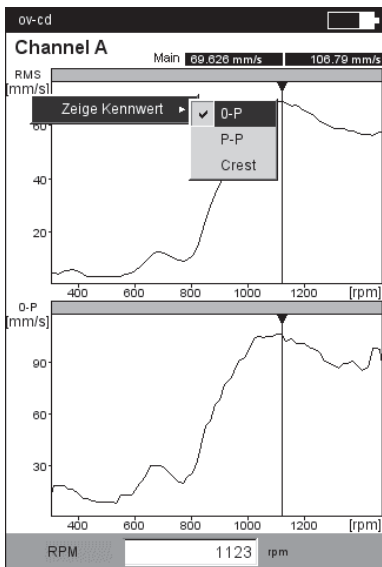

Spectrum - RPM
Individual display

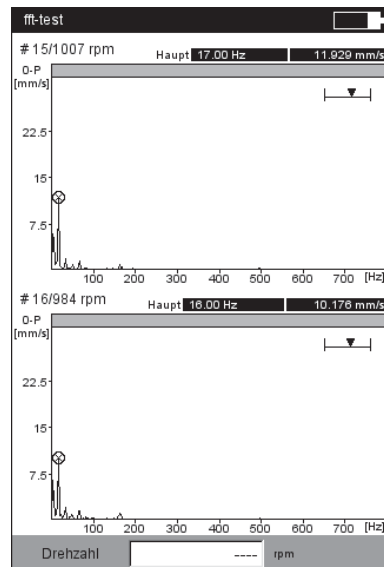

Spectrum - RPM
Waterfall diagram

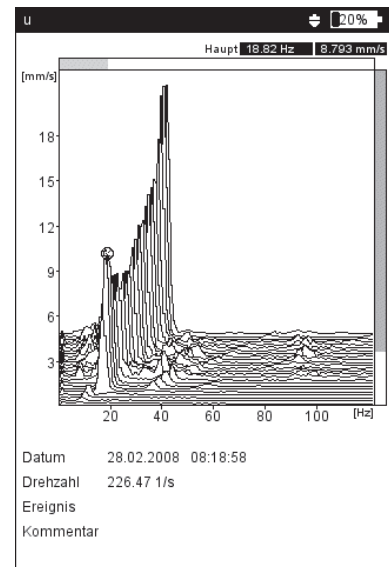

C.3 'Phase - RPM' measurement type

This type of measurement records the phase amplitude and the phase angle in dependence on the RPM. Points of resonance are indicated by RPMs with increased amplitude and a simultaneous jump in phase angle by (ideally) 180°. The results are displayed either in a Bode diagram or in a Nyquist diagram.



Bode diagram

The upper curve shows the amplitude progression and the phase is displayed in the lower screen. The Zoom function applies to both diagrams.

If the 'Continuous Phase' option in the display setup is enabled, a number of dotted horizontal lines may appear in the phase diagram under certain circumstances. These lines represent the '360° - 0°' transition that can occur any number of times due to the constant continuation of the phase progression.



Note

Changing the type of diagram

Press the F key and click with the joystick.



Averaging cancellation if rpm deviation > 10%

VIBXPRT EX records a time signal block per shaft rotation and combines multiple blocks to an average signal, depending on the averaging number. If the rotational speed varies by more than 10% during averaging, VIBXPRT EX aborts the averaging and uses the averaged signal to calculate the amplitude and the phase angle. These values are only saved if the rpm deviation set in the measurement setup is reached.

Runup / Coastdown:

Left:
Phase - RPM (Bode diagram)

Right:
Phase - RPM (Nyquist diagram)

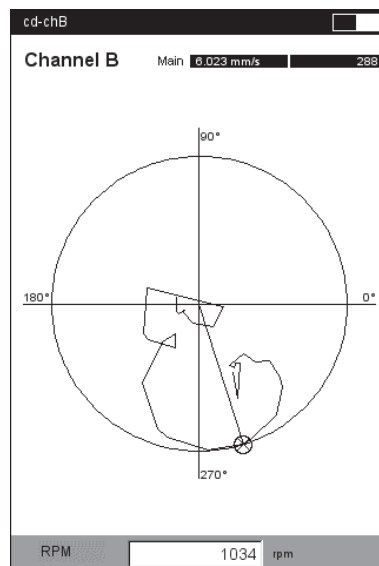
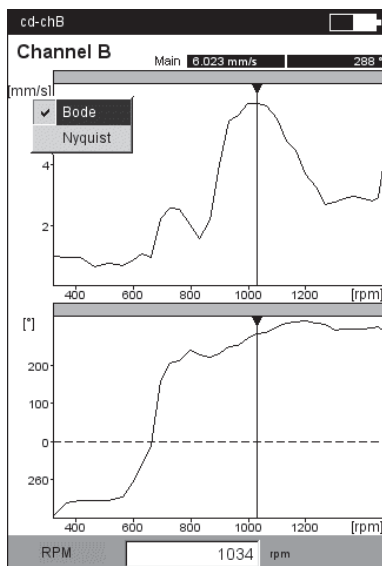

C.4 Two-channel measurement

The following differences appear when displaying the results of 2-channel measurements.

Spectrum - RPM

Just one spectrum per channel is displayed on the results screen. Scrolling with the '+/-' key acts on both channels.

In the waterfall diagram, you must select the channel whose spectrum is to be displayed.

Characteristic value - RPM / Phase - RPM

In 2-channel measurements, it is possible to display the channels individually or together in one screen. Press the F key and select the option 'Display Channel -> A , B or A+B'.

'Channel A+B' display:

The curve for channel B is shown by a thicker line. Two polar diagrams appear in the Nyquist diagram.



Note

The delta cursor is not available for 2-channel measurements.

Runup / Coastdown - 2 channels

Display mode 'Channel A + B'

Bode diagram (left)

Nyquist diagram (right)

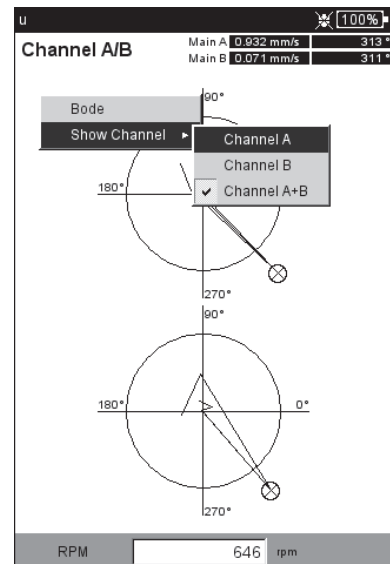
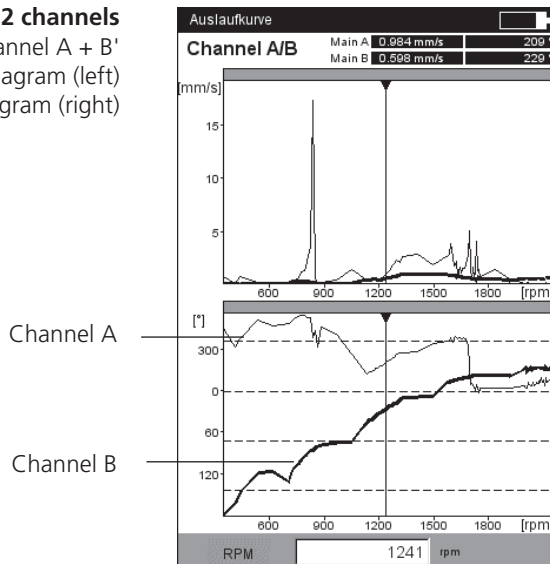

C.5 Measurement rate (number of measurement points)

An important criteria for the quality of the results is the number of measurement values saved. The more measurement values, the more meaningful the measurement. The decisive factor here is how quickly the machine reaches the operating RPM or how quickly it comes to a standstill. The greater the time required for this, the more measurement values VIBXPERT EX can record. If the time period is too short for a sufficient number of measurement values, the 'Overlap' parameter can be increased in the measurement setup in order to increase the measurement rate (see below).

In machines the coast up and down very slowly, the number of saved measurement values can be very high without significantly improving the quality of the results. In this case, you can reduce the measuring rate - i.e. the number of saved measurement values per change in RPM - and save memory space at the same time. In the measurement setup, set the 'RPM deviation' parameter to a higher value - either in the measurement setup or immediately before beginning the measurement. In the example below, a measurement is saved whenever the RPM (rotational frequency*) changes by 1 Hz.

* 1Hz = 60 rpm.

The 'RPM deviation' parameter in the measurement setups set at the factory can also be changed.



Note

To display the number of measurement values saved, press the MENU key in the result screen and click on 'Result Details' (see below).

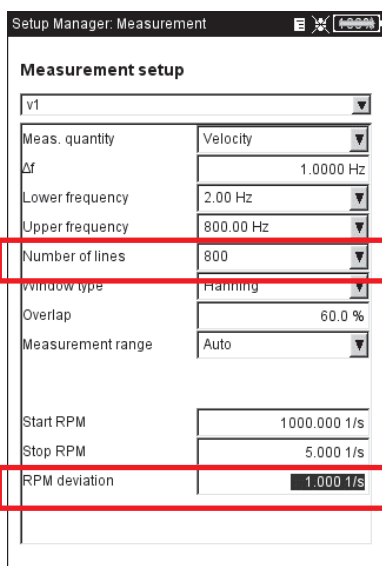

Details	Values
Job	Coastdown / Startup
Addition info	Number of measurement points: 77
Channel	A
Channel	B

Left:

Runup / Coastdown - meas. setup
Setup parameters 'overlap', RPM deviation

Right:

Number of saved meas. values
in the 'Result details' screen

* The movement of the shaft axis at a **constant** rpm is recorded with an orbit plot.



Note

Shaft centerline plot

A shaft centerline plot records the movement of the shaft axis* in a journal bearing while the machine is running up or coasting down (e.g. turbine). Conclusions can be drawn from the shaft centerline plot on the fault conditions - such as oil whirl or oil whip in journal bearings.

A description of the measurement procedure with VIBXPRT can be found in the Technical Information CM # 18 'Analysis of radial shaft movement in journal bearings' - available free on our website.



Environment: Outside EX area

Measurement task:

2-CHANNEL COASTDOWN - PHASE, MEAS. QUANTITY: DISPLACEMENT

Parameters set up in the measurement task manager (see below)

- As the measurement task, select 'Dual Amp. Startup/Coastdown User'.
- As the measurement setup, select 'Dual Coast Down User'.
- Set the following parameters in the measurement setup:
 - MEASUREMENT QUANTITY = Vibration displacement
 - LOWER FREQUENCY = DC
- In the sensor setup, select the displacement sensors (e.g. VIB 6.640).

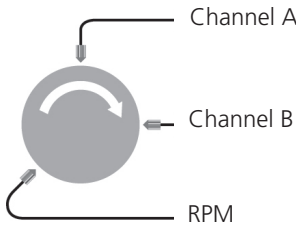

Requirements for correctly interpreting the results

- The sensors are installed at an angle of 90° to each other.
- The shaft always turns from sensor A to sensor B. The position of the sensor relative to the direction of rotation can be adjusted after measurement.
- The static shaft position can be displayed as an offset in the shaft centerline plot.

Shaft centerline plot

Setups in the task manager

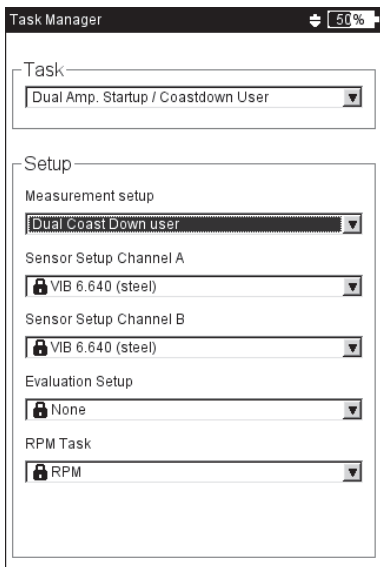

Parameters in the meas. setup

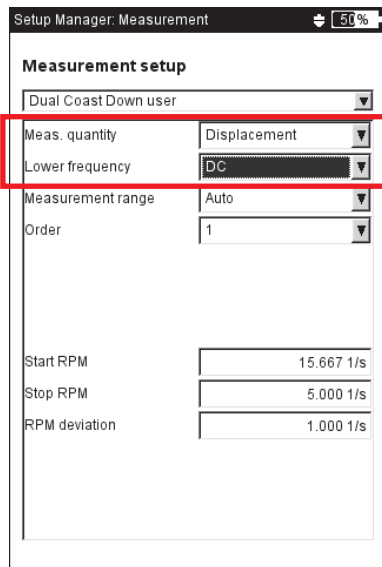

Results display

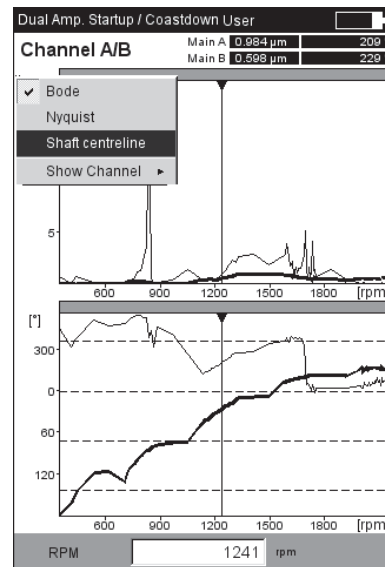

Starting the measurement and displaying the shaft centerline plot

- Click on the measurement task icon and then on 'Start'. During data collection, the values for the DC component are displayed in the measurement data dialog window.
- After measurement, press the F key and click on 'Shaft centerline'. The shaft centerline plot appears (see below).



Static shaft position

By default, the DC component at the smallest rpm defines the static shaft position in the shaft centerline plot. The static shaft position can also be set after measurement using other methods:

- Press the MENU key in the results screen.
- Select 'Shaft centerline' and click on 'Get shaft rest position'.
- Select one of the following methods:
 - CURRENT CURSOR: Cursor position indicates the rest position.
 - ENTER MANUAL: Enter the coordinates for every channel.
 - MEASURE: Use the 'Static shaft position' measurement task.
 - CHOOSE FROM FILE: Import from a 'Static shaft position' result file.

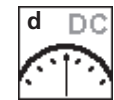

Static shaft position

Sensor arrangement

The arrangement of the sensor relative to the direction of rotation influences the position and orientation of the shaft displacement in the diagram. Because the direction of the shaft displacement with respect to the direction of rotation is a characteristic of certain fault types in journal bearings, the correct sensor arrangement in the diagram is important. If necessary, the arrangement of the sensors and the direction of rotation can be mirrored:

- Press the MENU key.
- Select 'Shaft centerline' and click on 'Fit sensor adjustment'.
- In the next window (sensor geometry, at right), click on 'Flip A-B'.

Mirroring the sensor arrangement

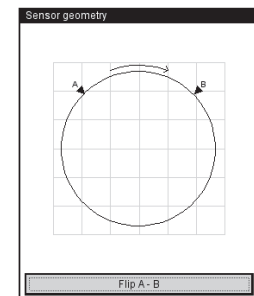

Shaft rest position

Methods for reading in the rest position

Measurement value: channel A / channel B

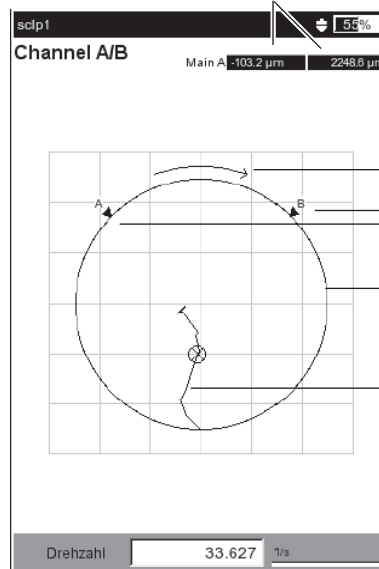
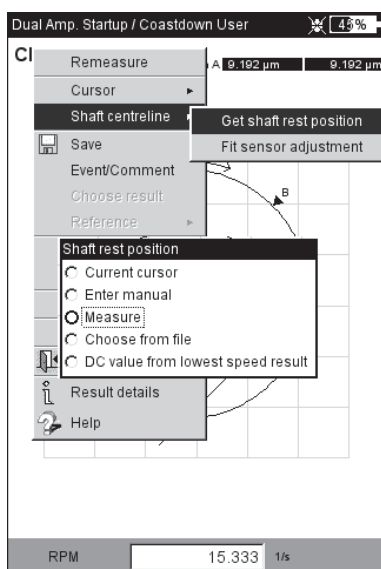

Shaft centerline plot

- Direction of shaft rotation
- Sensor A and B at 90° to each other
- Shaft bearing - does not contain absolute bearing dimensions
- Shaft centerline displacement during measurement
- rpm at cursor position

Synchronous Phase

1 channel
'Overall values' tab



2 channels
'Advanced' tab



Cross Channel Phase

2 channels
'Advanced' tab



Phase measurement

The phase measurement is used to identify machine faults that cause lines at the same position in the spectrum (e.g. static/ dynamic unbalance). The *synchronous phase measurement* determines the amplitude and the phase angle of the vibration pointer from the RPM-synchronous components of the vibration signal. The reference transducer in this case is a trigger sensor. To simplify the diagnosis, the measured signal is processed in an order filter. For example, an unbalance causes severe vibrations in the first order whereas alignment faults dominate in the second order.

Synchronous phase measurement can be performed in one or in two planes. With two channel measurements the phase difference in both planes can be determined. This indicates whether, e. g. static, dynamic or coupled unbalance is present.

In contrast to synchronous phase measurement, the *Cross Channel Phase Measurement* is determined without a reference transducer. The measurement is carried out as a 2-channel measurement where, in addition to the signal amplitudes, the phase difference of the two channels is determined. Depending on where and in which direction measurements have been carried out on the machine, the phase difference is an indicator of the presence of a machine fault.

Enter the RPM of the machine before the measurement as a measurement parameter. The size of the RPM range to be evaluated is set in the measurement setup. Note the setting of the active edge for the trigger signal.

The measurement result is displayed in a polar diagram. The respective values for amplitude and phase angle are displayed in the result field below the diagram (see below).

Left:
Synchronous phase measurement

Right:
Cross Channel phase measurement

A: Result for channel A

B: Result for channel B

Max. display range

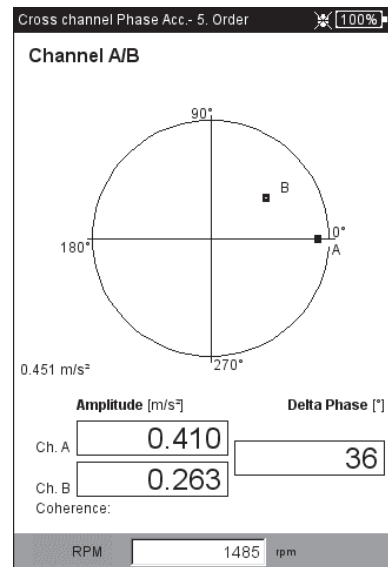
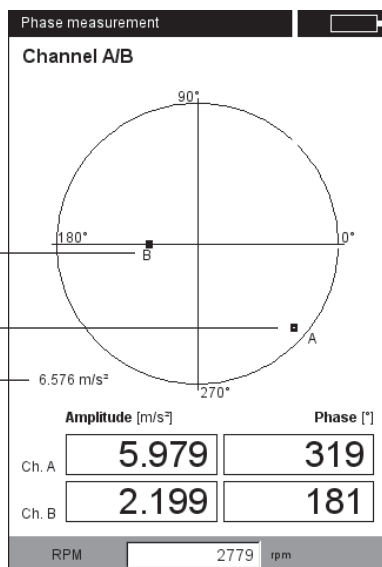

Order filter

After the measurement, the order filter can be changed with the +/- key.

Alternative:

- Press the MENU button and select 'Order'.
- Move the joystick to the right, and select the required order (1-5).



Scaling

To magnify the scaling of the diagram, move the joystick up. If a phase vector then moves out of the diagram as a result, the maximum display range is also specified relative to the longer (no longer visible) vector (e.g. '92% of A').

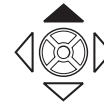

Coherence (Cross Channel)

The coherence factor is a measure of the quality of the measurement and indicates how strongly the signals of both channels are coupled. If the factor is close to 1, the measurement is usable.

Phase trend

If you would like to record the phase trend as a function of time or rpm, save the individual measurements by 'Appending' to a file. In the display setup for the trend display, select either 'Time' or 'rpm' ('Phase over...' parameter). The rpm value and the date of each measurement appear in the lower display field.

To open an individual measurement result in the trend display, press the F key, and click on 'Details'.

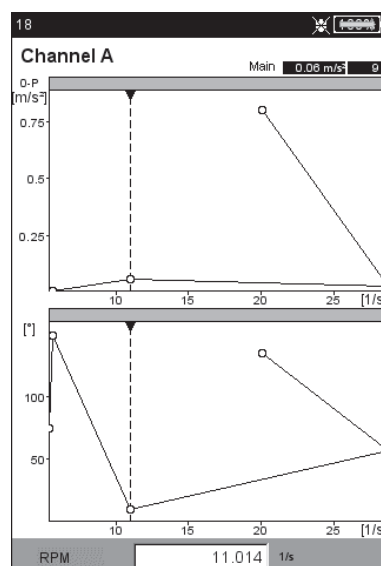
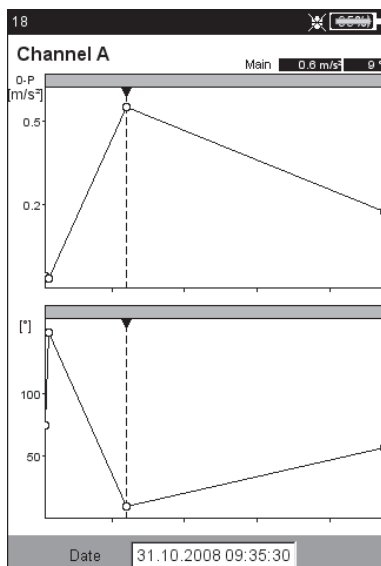

Left:
Time-based phase trend

Right:
RPM-based phase trend

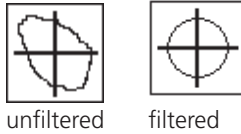

* The movement of the shaft axis while the machine is running up / coasting down is recorded with a shaft centerline plot.

Orbit

The movement of the shaft axis* at constant speed is measured with two non-contact sensors that are installed in an angular distance of 90 °.

This enables identification of machine faults and damage to the shaft that become apparent in the vibration behavior of the shaft and directly affect the path of the shaft (e.g. unbalance, misalignment, shaft crack, rotation fault - for more details, see VDI 3839 Sheets 1 and 2). When using 'filtered orbit', the signal is processed in an order filter and therefore requires a keyphaser to provide a reference.

Environment: Outside EX area

A typical measurement installation is shown in the following figure:

- The two displacement sensors are mounted in a single measurement plane at an angular displacement of 90° on the machine. If this angular displacement is not possible, you can mount the sensors at any angular displacement between 5° and 175°. Then enter the angular displacement in the measurement setup ('Sensor angle' parameter). However, measurement accuracy is limited when the sensor angle $\neq 90^\circ$.
- The sensor on channel A defines the X direction and the 0° position.
- The keyphaser is mounted in the 0° position.
- Note the setting of the active edge for the trigger signal.



Note

The procedure for an orbit measurement is described in the following standards: ISO 7919, ISO 10817-1, VDI 3839 Sheet1.

A description of the measurement procedure with VIBXPERT can be found in the Technical Information CM # 18 'Analysis of radial shaft movement in journal bearings' - available free on our website.

Typical installation
with inductive displacement sensors

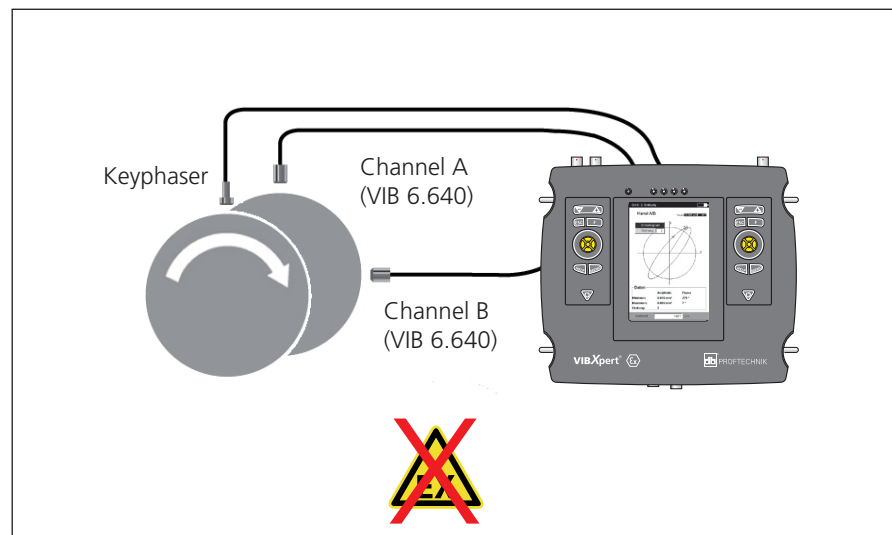

The signals of both sensors are displayed either as individual signals or as an orbit in a polar chart. The maximum and minimum phase vectors and the order filter are displayed in the data field on the orbit display. The angular coordinate of the cursor indicates the angular distance to Keyphaser point*, which is marked in the orbit with an arrow. To check the phase stability, multiple rotations of the shaft can be displayed in the orbit diagram.

* Keyphaser point: Point in the orbit, at which the reference mark on the shaft passes the Keyphaser.

Cursor and Zoom

A main and delta cursor are available for evaluation. The Zoom function is controlled with the '+/-' key or with the joystick.

Changing the diagram type

After the measurement,

- Press the F key, and click on 'Individual signals' or on 'Orbit' respectively, or..
- Open the Display Setup and select the diagram type (see below).



Changing the order filter

After measurement press the F key, and select the required order in the 'Order' field. The order of '0' corresponds to the unfiltered signal and can only be adjusted if the measurement parameters in the measurement setup and the transducer setup are the same.

Orbit, unfiltered

If a keyphaser is not available, record an 'unfiltered' orbit. The angular displacement of the sensors for this measurement task must equal 90°! To stop the measurement, press the joystick.



unfiltered

For time-based average enter the shaft RPM value and the number of rotations, if necessary: Press the MENU key and select 'Post-processing / Time-synchronous average'.

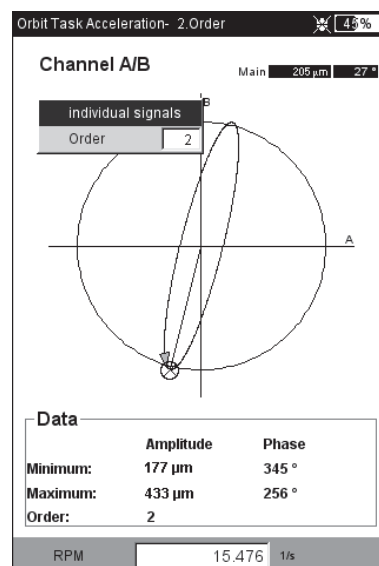
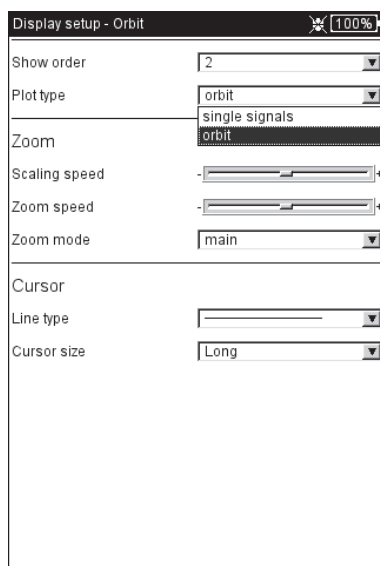

Left:
Change diagram type

Right:
Orbit plot, 2nd order

Envelope spectrum for roller bearing analysis



Envelope spectrum for gearing analysis



Envelope analysis

Envelope analysis is a proven method for detecting periodic impacts in the vibration signal of a machine. It is mainly used for the diagnosis of roller bearing damage and tooth damage and is based on the demodulation of amplitude modulated vibration signals.

Periodic impact sequences in a component excite high frequency machine resonances that serve as a carrier signal of the low frequency impact signal. To separate the low frequency modulation from the high frequency resonance, the signal is filtered with a highpass filter, rectified and then filtered using a lowpass filter. Consequently, the remaining signal consists of the modulation signal only - the so-called 'envelope' - from which the FFT of the envelope frequency spectrum can be calculated.



Note

VIBXPRT EX saves the envelope time signal filtered last together with the envelope frequency spectrum.

To display the time signal, press the MENU key and select 'Info / Time waveform' (see below).

VIBXPRT EX provides two methods for calculating the envelope: Highpass and lowpass filtering is carried out on the basis of hardware or software.

In the case of hardware filtering, the signal is processed in a filter chip. This method is identical to that used in the VIBSCANNER FFT data collector and, hence, is suitable for comparison measurements with both devices.

Software filtering, on the other hand, calculates the envelope with the aid of an algorithm. This method is more flexible than the hardware-based method and offers more filter combinations.

Left:
Measurement setup
for envelope spectrum

Right:
Envelope spectrum and
appropriate time waveform

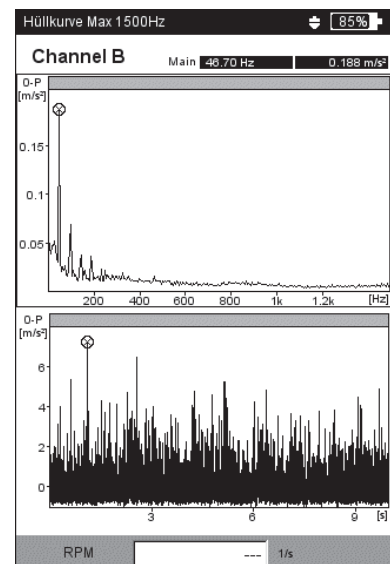
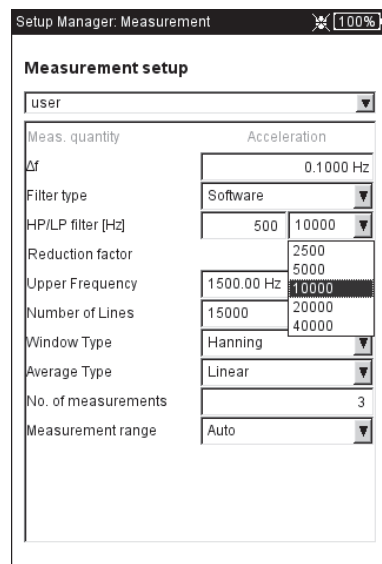

Cepstrum analysis

A cepstrum is the 'spectrum of a spectrum' and is particularly suitable for detecting regular structures in a frequency spectrum. Above all, in the case of complex patterns with many harmonics and sidebands - that frequently occur if roller bearings or gearings are damaged- a cepstrum simplifies the evaluation of the measurement data.

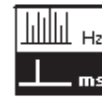

Cepstrum

User-defined measurement variables

As well as measurement tasks with fixed specified measurement variables, VIBXPRT EX provides measurement tasks where the measurement variables can be freely defined. The voltage ($\pm 30V$, AC/DC) or current ($\pm 30mA$, AC/DC) can be connected as an input signal and recorded as a characteristic value, as a time waveform* or as a spectrum*. The assignment of the input signal to the measurement variable is specified by the 'Measurement Variable' and 'Unit' parameters in the transducer setup.



Overall v.



Overall v.



Time wf.

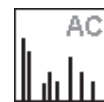

Spectrum

Examples of user-defined measurement variables:

- Measurement of the pressure as a current level ($4-20mA$, DC). Connection to pressure transmitter.
- Measurement of the flow rate as a current or voltage signal ($4-20mA / 0-10V$, DC). Connection to flow rate measuring device.
- Measurement of the sound pressure as a time signal or spectrum. Connection to a microphone.
- Displacement measurement (inductive sensor VIB 6.640).

* DC measurement for time waveform, spectrum.

Only the following cables can be used as sensor cables:

VIB 5.433 - Connection cable for low voltage signals

VIB 5.434 - Connection cable for low current signals

These cables may not be used in an explosive environment!



Attention!

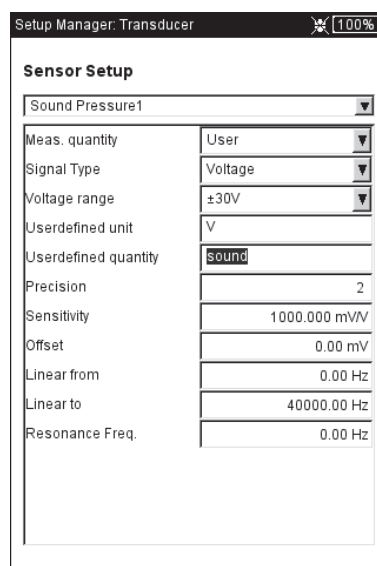
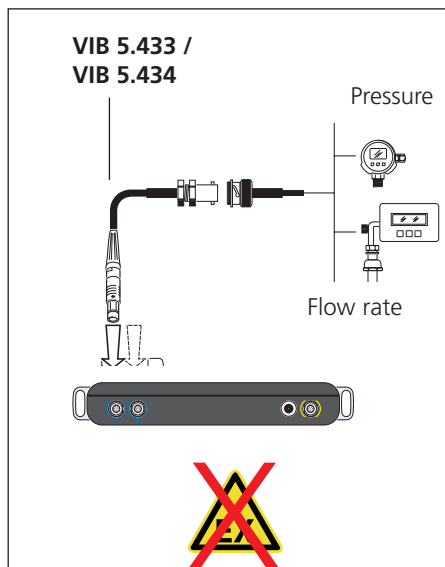

Sensor parameters for sound pressure measurement



* e.g. shock pulse characteristic value + envelope + velocity spectrum

Multi-measurement task ('Multitask')

A multi-measurement task shortens the measurement times by combining several, similar measurement tasks*. It is particularly time-saving in the case of measurement tasks that are measured at the same measurement location with the same transducer and the same filter settings. In this case, VIBXPRT EX only carries out one signal measurement and calculates the results of the individual measurement tasks from this.

Initially, no measurement results appear in the Results screen, just information on the status of the measurement together with the assessment of the results (see below).

Evaluating the results

The evaluation of the results is carried out on the basis of the stored thresholds. If a threshold is exceeded, the corresponding symbol appears in the 'Status' column (see below left).

- For a detailed view of the evaluation scale, press the MENU key and click on 'Evaluation Overview' (see below).

Result of the single measurements

- After the measurement, move the joystick until a black frame appears around the list field.
- Click with the joystick to activate the list field.
- Click on the measurement in the list whose result is to be displayed.

Alternative:

Highlight the measurement, press the MENU key and click on 'Display Result'.

- Press ESC to return to the list field.

Multitask
Result display (left)
Evaluation (right)

Status / evaluation icons

- | | |
|--|------------|
| | Alarm |
| | Warning |
| | Prewarning |
| | Measuring |
| | Measured |
| | Error |

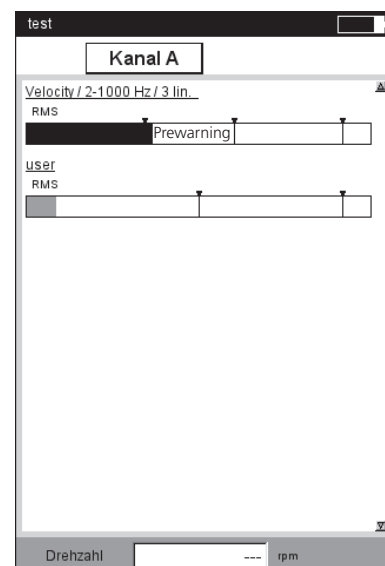
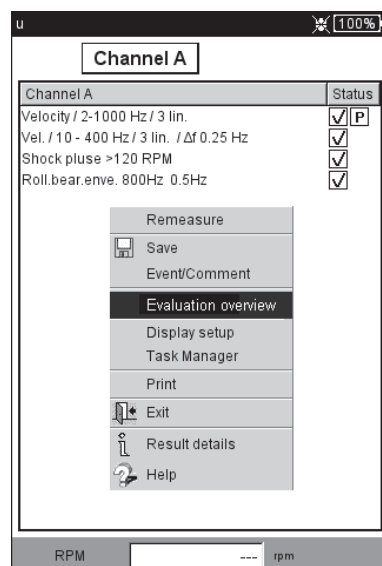

Creating a multi-measurement task for a route / machine template

Multi-measurement tasks for this operating mode are created in the OMNITREND editor for routes or machine templates. To do this, activate the 'Multitask' option (see below). OMNITREND then automatically combines the relevant measurement tasks into a single multi-measurement task.

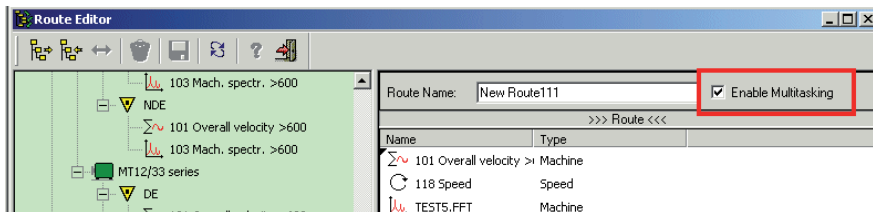

Creating a Multitask
(in the OMNITREND route editor)

Breaking down a multi-measurement task

To measure the measurement tasks of a multi-measurement task individually in the route/machine template, proceed as follows:

- Open the selection list of the measurement tasks.
- Highlight the multi-measurement task.
- Press the MENU key and click on 'Break down Multitask' (see below).

This process is not reversible!



Note

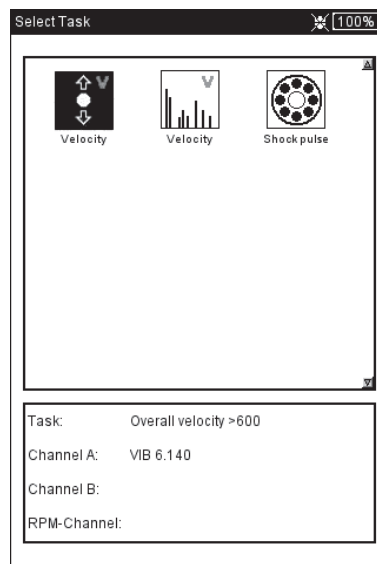
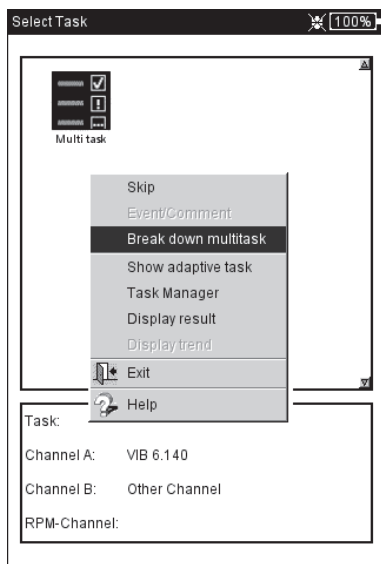

Left:
Breaking down a multi-measurement task
(Route / Machine template)

Right:
Individual measurement tasks

Multi-measurement task in the 'Multimode' operating mode

Multi-measurement tasks are created in the Task Manager:

- Open the Task Manager.
- Select the upper menu 'Measurement task' and press the MENU key.
- Click on 'New' and enter a name for the new measurement task.
- In the 'Start measurement' field, define whether the measurements should be started consecutively or simultaneously. With the 'Synchronous' setting, you can additionally define a trigger channel ('Synchronous + Channel ...').

The measurement task, sensors and trigger parameters can be set up in the respective tabs:

TASK TAB

Here you can set the sensor for each channel (A/B), and define whether the rpm should be recorded as well.

CHANNEL A / CHANNEL B TAB

Here you can define the measurement task for each channel:

- Press the MENU key and click on 'Select task' (see below). The import wizard appears, in which you can select the individual measurement tasks in three steps (see also the next section, 'Dual measurement').

TRIGGER TAB

The trigger settings only apply when the multi-measurement task is to start with a trigger (see 'Start measurement' above). The first measurement starts as soon as the *Trigger level* is exceeded and the *Trigger start time* has elapsed. The trigger levels relates to the *measurement range*.

Multitask (Multimode)

Selecting individual meas. tasks (left)
Setting the trigger parameters (right)

Measurement task
Evaluation setup

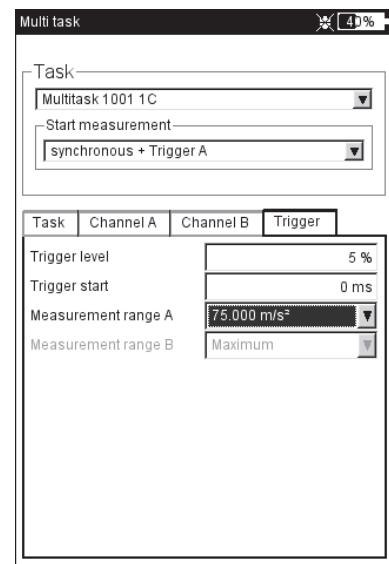
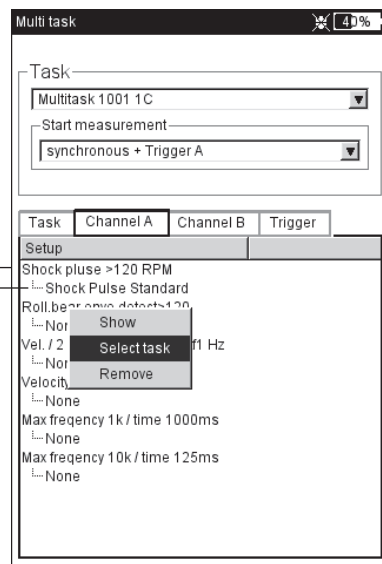

Dual measurement (1+1)

In the case of a dual measurement, vibration measurements can be carried out as a overall value, spectrum or time signal on both channels at the same time, such as

Overall value on channel A and spectrum on channel B, or
Spectrum on channel A and time signal on channel B, etc.



Creating a new dual measurement

- Open the Task Manager.
- Highlight the drop-down menu in the 'Measurement Task' field, press the MENU key and click on 'New'.
- Enter a name for the new measurement task in the Text Editor.
- In the 'Start measurement' field, define whether the measurements should be started consecutively or simultaneously on channel A and channel B.

If the averaging type is set to “synchronous averaging” for one channel, the “asynchronous with trigger” start option is identical to the “synchronous + trigger A” start option - i.e., measurements start at the same time on both channels, with channel A acting as the trigger.



Note

- In the 'Setup' field, select the respective measurement parameters for channel A and channel B.

Only the setups of one measurement type can be selected for each channel as a measurement setup - i.e. either overall values, or spectra, or time signals. To select the setups of another measurement type, proceed as follows:

- Highlight the 'Measurement Setup' drop-down menu, press the MENU key and click on 'Import Task' (see below).

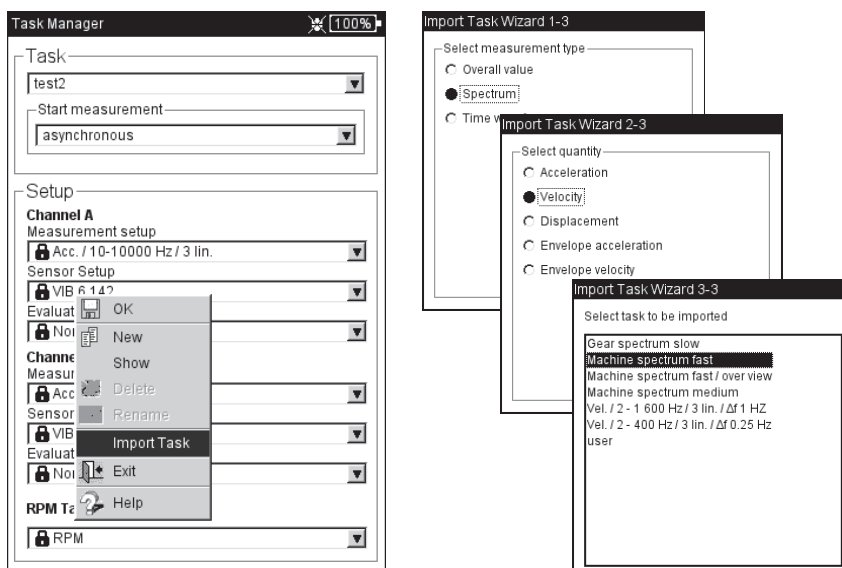

Left:
Importing a task

Right:
Import wizard
Three steps to reach the desired measurement task

The 'Import wizard' appears which is used to select the measurement type, the measurement quantity and the measurement task in three steps (see previous page). Transducer setup and evaluation setup of the measurement task will be automatically applied.

Results screen

As soon as both measurements are completed, the blue LED lights up if no thresholds have been exceeded or no measurement errors have occurred.



Note

The functions that can be triggered via the keyboard only apply to the active pane, which is indicated by a frame. As well as the pane for channel A and channel B, the entire screen also counts as a pane!

To evaluate or repeat one of the two measurements, activate the corresponding pane as follows:

Navigation in the Results screen
Frame color (gray/ black) indicates the pane status

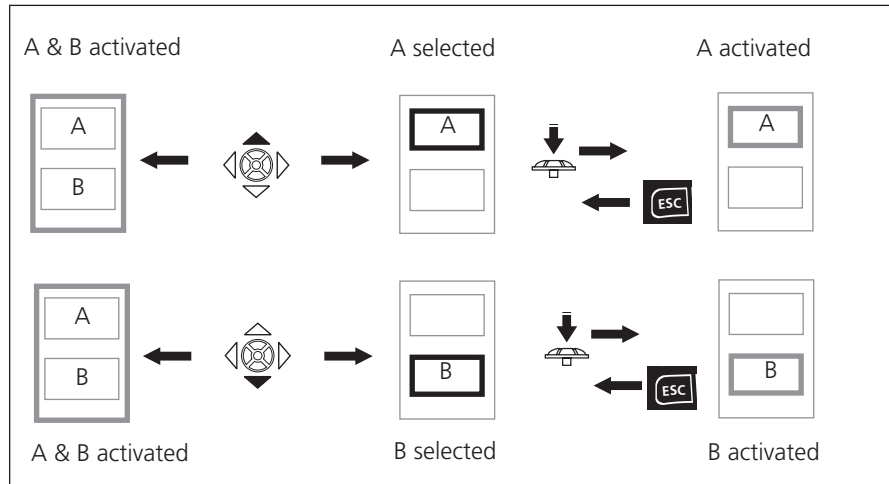

Dual task

(here: Spectrum / time signal)

Partial window for channel A is selected (black frame)

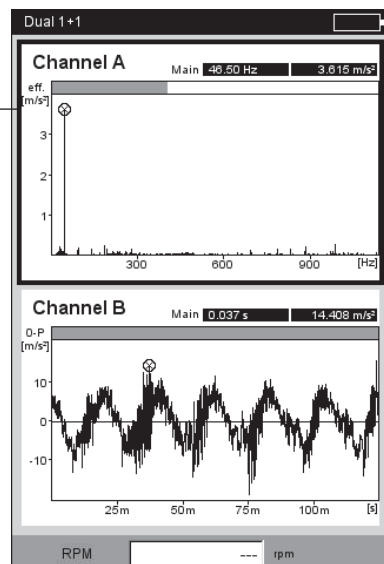

Impact test - 1 channel

The Impact test is used to determine the resonance frequency of a structure. In the case of a rotating machine, it is possible to determine the RPM ranges in which vibrations are disproportionately amplified by resonance* and could damage the machine. These ranges must then be avoided during operation and should be passed through as quickly as possible during runup and coastdown of the machine.

The one-channel impact test only records the system response. The two-channel impact test also records the excitation. Any source of vibration that contains as many frequencies as possible is suitable for exciting a structure - such as a pulse-blow with a rubber hammer.

- Check and change the measurement parameters, if necessary.
The measurement can take place with the machine running or at a standstill. The signals from a running machine can be hidden using the so-called 'negative averaging method'.
- Attach the transducer to the machine - either with a magnet or, even better, with a screw fitting.
- Set the number of individual measurements in the measurement setup (e.g. 2 measurements, see below).
- Start the measurement by clicking on the task icon (see above).
- When the message 'Wait for trigger' appears, excite the machine with a suitable rubber hammer: Strike near to and in the direction of the transducer once per measurement.
- For each single measurement, strike exactly the same location once with the hammer.

After each single measurement, the result can be accepted or discarded (see below). After all measurements have been completed, the averaged final result appears together with the 10 highest amplitudes in the spectrum.



* e.g. excited by an imbalance or misalignment

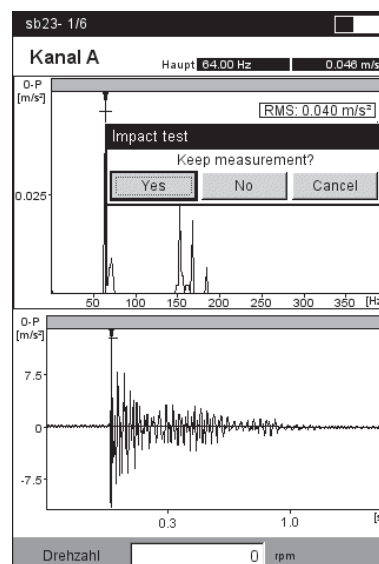
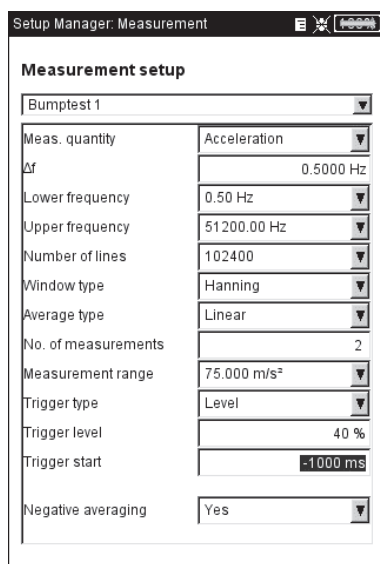

Left:

Setup parameters for impact test

Trigger Start < 0 : Signal is also recorded before the excitation

Right:

Measurement after hammer strike

Spectrum with resonant frequencies and measured time signal



Note

Tips for setting the measurement parameters

Set the "Trigger Start" time to a negative value in order to record the signal before the excitation.

If the measurement starts before the excitation, increase the trigger threshold in the measurement setup by approximately half.

If the response signal overloads, increase the 'Measurement Range' parameter in the measurement setup accordingly.

Measurement with the machine running

- Enable 'Negative averaging' in the measurement setup.
- Perform the individual impact tests.
- Click on 'Start' in the window that opens to measure the reference spectrum - without producing a machine excitation!
- Click on 'Stop' when a sufficient number of reference spectra have been recorded and averaged to form a result.



Displaying the results

- Activate the upper display field with the F key.
- Press the MENU key and click on 'Choose Dataset'.
The results of the impact test, the average final result and the reference measurement (negative averaging) are listed here and can be displayed individually by clicking (see below).
- To close the list, press on the ESC key.



Repeating individual measurements

- Activate the upper display field using the F key.
- Press the MENU key and click on 'Remeasure'.
- Click on the respective measurement in the list.

Left:
Reference measurement
is required when measuring on a running machine

Right:
Dataset selection
Single measurements /
Averaged final result

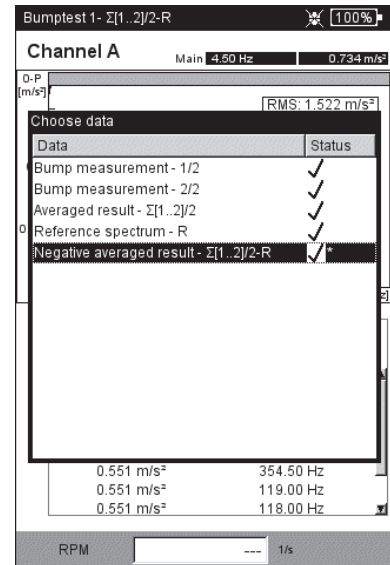
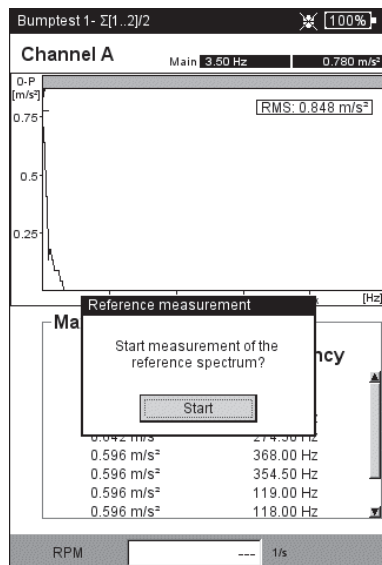

Modal analysis - two-channel impact test

The two-channel impact test is used to visualize the dynamic behavior of a structure and to detect operating-critical natural vibration forms.

ODS - Operating Deflection Shape

To record the vibration modes of a structure, the vibrations are recorded at multiple measurement locations during operation and set in relation to a reference measurement location. The individual vibration modes can be calculated from the relative amplitudes and phase differences of the measurement locations to the reference and can be displayed as an animation*.

Excitation with impulse hammer

If the structure is excited with a suitable excitation source (e.g. impulse hammer) and the structural response is measured with a vibration sensor, the resonance frequency can be calculated.

The described measurement methods are implemented in the following measurement tasks:

- ODS
The sensor on channel B records the 'excitational' force and serves as the reference point for all other measurement locations. The sensor on channel A is attached to the designated measurement locations of the structure in sequence and records the respective structural response.
- Impact test with *impulse hammer*
This measurement task is similar to the one-channel impact test; channel B records the excitation and is the trigger for the measurement. To take measurements on a running machine, the 'negative average' averaging procedure is available.

A. Selecting the task and starting the measurement

- Select the task icon 'Modal analysis' (see above).
- Press the F key to open the task selection window.
- Click on the respective task (ODS or Bump test with impulse hammer). The selection window closes.
- Click again to start the measurement.

The measurement procedure with the *impulse hammer* is essentially identical to the one-channel impact test: excitation, measurement, recording of result - excitation, measurement,..., end result (see also previous section).



Modal / ODS

* additional information are available on request.

Example of an ODS animation:

Maximum displacement of a mounting platform .

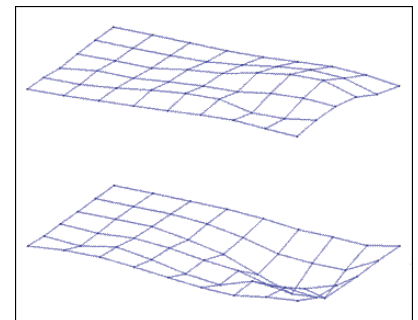

Selecting the measurement task and starting the measurement

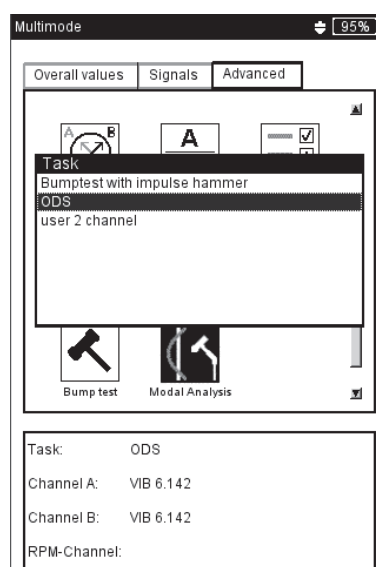

Connect the impulse hammer with the force sensor to channel B, and always connect the sensor for the system response to channel A. After the last individual measurement is completed, save the data set in a file.

With the ODS measurement, the measurement starts without a trigger, which means that spectra are recorded until the number of measurements is reached (standard = 4).

B. Saving

With the ODS measurement, you can assign a point number and a direction to each impact result to document the position of the measurement location and the measurement direction. Multiple impact results can be contained in a single file.

C. ODS results

During measurement, the system response appears in the upper window and the excitation in the lower window - either as a spectrum or time waveform.

After the individual measurements are completed, the final result appears. The upper window shows the transfer function while the lower window displays the coherence function.

- Press the MENU key and click on ...
 - ... 'Choose dataset' to call up the individual results.
 - ... 'Choose result' to open the result selection dialog window. Here you can open the result of another measurement or start a new measurement. This dialog window appears automatically when saving when the corresponding option is activated in the display setup.

Left:
Result of an ODS measurement for one measurement location

Right:
Selecting a result from a file

Transfer function*

Coherence function

* Select the calculation procedure for the transfer function in the measurement setup.
(Parameter: FRF CALCULATION)

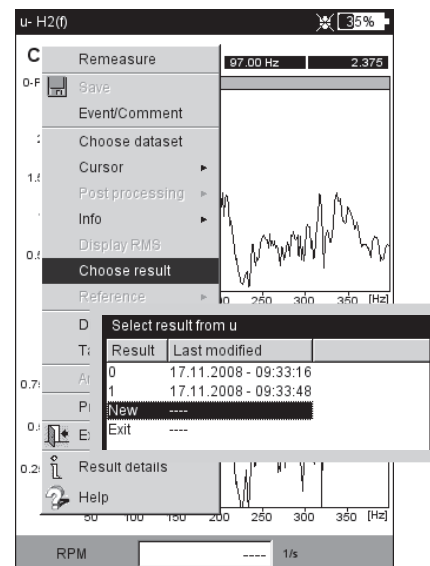
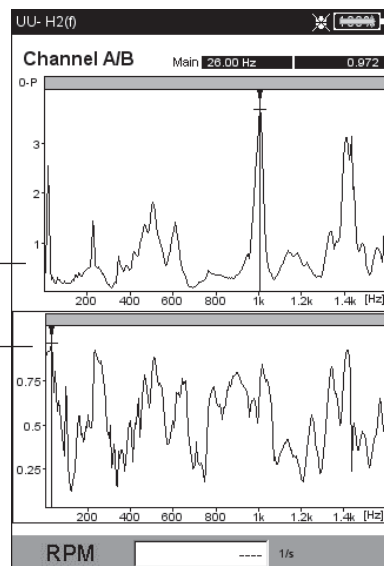

The measurement tasks described on this page are only available in the 'Route / Machine template' mode. The measurement parameters are set in the OMNITREND PC software.



Note

TrendingSpectrum

A TrendingSpectrum is a measurement template for the route mode. It can be used to make data collection significantly faster and more efficient. A TrendingSpectrum is based on a time signal measurement. Based on the TrendingSpectrum, VIBXPERT EX first generates a spectrum, which in turn is used to calculate up to 30 characteristic overall values. The characteristic values result from the frequency bands defined in OMNITREND and are used for condition monitoring when recorded in the form of a trend.

Based on the spectrum, VIBXPERT EX also calculates a time signal according to the settings in the OMNITREND software. The measurement quantity of the calculated time signal may differ from the measurement quantity of the measured time signal.

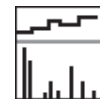

TrendingSpectrum
(Amplitude)



TrendingSpectrum
(Envelope)

Order spectrum

In an order spectrum, the frequencies are recorded and displayed as a multiple of the shaft rotational frequency (= order). In these measurements, the RPM is recorded at the same time as the vibration signal and is taken into account when the spectrum is calculated. If short-term, system-related fluctuations in the RPM occur, the sample rate of the time signal is adjusted accordingly ('resampling') to avoid a 'smearing' of the frequencies.

An order spectrum cannot be converted into a frequency spectrum, since the time and thus the frequency information are lost through the resampling procedure.

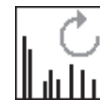

Order spec-
trum

Order-based spectrum

With this type of spectrum, the frequencies are converted into orders*. The RPM is measured, manually entered or passed as a parameter by the OMNITREND software. The maximum order to be displayed is also required. Order-based spectra are advantageous when machines run at different RPMs for process-related reasons because the spectra are only comparable in relation to the RPM.

* Shaft rotational frequency = 1. Order

DC measurements

For the following measurement tasks, the DC component in the signal can be recorded in addition:

- Time waveform with the measuring quantity set to vibration displacement or user-defined.
- Spectrum with the measuring quantity set to vibration displacement or user-defined.
- Phase with the vibration displacement measuring quantity .
- Coastdown, amplitude/phase with the measuring quantity set to vibration displacement or user-defined.
- Orbit (unfiltered), with the measuring quantity set to vibration displacement or user-defined*.
- Time waveform recorder, with vibration displacement measuring quantity.

Application examples

The DC component in the *time waveform* can be evaluated when process parameters or distances are measured.

When a *2-channel coastdown curve* is measured with the *vibration displacement* measuring quantity, the shaft centerline plot during runup or coastdown in a machine with journal bearings can be calculated from the DC component of the signal.

Setting up a measurement task for measuring the DC components

You can activate a DC measurement in the measurement setup using the 'Lower frequency = DC' parameter. You must also set up the 'Vibration displacement' or 'User-defined' measuring quantity and assign a suitable sensor.

Setting up a DC measurement
 Measuring quantity = 'Displacement'
 or 'User'
 Lower frequency = 'DC'

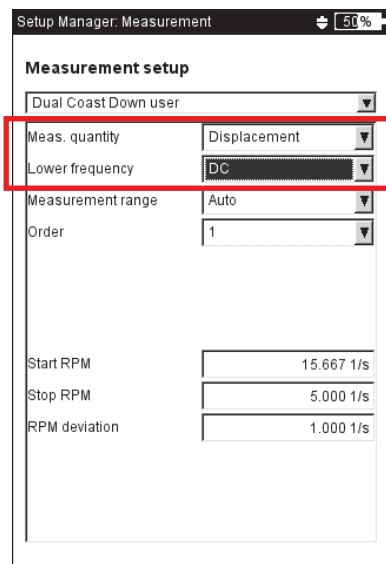

Measurement setup	
Dual Coast Down user	
Meas. quantity	Displacement
Lower frequency	DC
Measurement range	Auto
Order	1
Start RPM	15.667 1/s
Stop RPM	5.000 1/s
RPM deviation	1.000 1/s

Chapter 6: Appendix

This chapter provides information on how to use

- the numerical and text editors,
- the VIBXPERT utility software,
- the File Manager
- the VIBCODE transducer system.
- Instructions on handling and maintaining the VIBXPERT EX
- Technical data

Numerical editor

The numerical editor appears each time it is necessary to enter a numeric value (see below).

- To enter a numerical value, move the cursor over the character field and click on the required digit.
- To delete numerals, press the ESC key. Only the left digit of a number is deleted.
- The sign can be toggled at any time with ' \pm ' in the character field.
- Decimal places are entered as a period '.'.
- To save the value, press the MENU key and click on 'OK'.

Decimal places

Decimal places can only be entered if the 'Accuracy' of the respective quantity is not set to zero.

Value range

The permissible value range is defined in the 'Maximum' / 'Minimum' fields. If the value is outside of this range, the threshold that has been exceeded is displayed with a black background. In this case, the entered value cannot be saved.

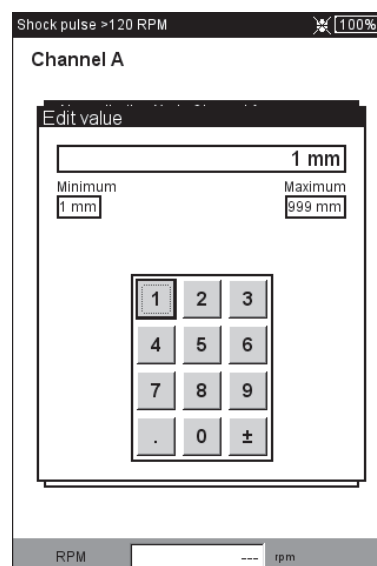

Numerical Editor

Text Editor

Entering text

- Press the F key until the cursor appears in the *character table* (see below).
- To enter the text, click on the respective characters in the table . If the required character is not included, then press the '+' key to display further character tables.
- Then press the MENU key and click on 'OK'.
- To cancel, press the ESC key.



Deleting text

- Press the F key until the cursor appears in the *text field*.
- To delete an individual character/word:
 - Place the cursor to the right of the character/word to be deleted.
 - Press the F key to switch the cursor into the character table.
 - Click on '<=' in the character table (backspace key, see below).
- To delete a text field:
 - Press the F key until the entire text field is highlighted.
 - Click once with the joystick.
 - Press the F key again to switch the cursor into the character table.
 - Click on '<=' in the character table (backspace key).



Note

Special characters (*Space, comma, +, /*) are not allowed in file names.

The *text defaults* field contains texts which you can accept and, if necessary, modify by clicking.

Text editor

Text defaults, only for
- Measurement task/ Create new setup
- Search route

Text field (one line or several lines)

Character table

'Backspace' key

A	B	C	D	E	F
G	H	I	J	K	L
M	N	O	P	Q	R
S	T	U	V	W	X
Y	Z	0	1	2	3
4	5	6	7	8	9
.	,	-	⏪	⏩	⏴

File Manager

The File Manager administrates the measurements which were saved in the 'Multimode' and 'Balancing' operating modes. In the 'PDF files' folder you will find the print files generated in the PDF format. You can print out or delete these here.

The File Manager is opened by ...

... clicking on the 'File Manager' icon in the start screen.

... selecting the 'Load file' menu option in the Multimode Measurement Task screen.

... saving a measurement result.



For opening and saving, only the files of the current measurement type are displayed (e.g. overall value - vibration acceleration). If you open the File Manager from the start screen, all files are displayed (see below).



Note

Functions of the MENU key

SAVE: Saves the measurement result.

OPEN: Opens the highlighted file

CREATE DIR: Creates a new folder

RENAME: Renames a file/folder

PRINT: Prints out a PDF file

COPY, PASTE, CUT: Copies, inserts, moves file/folder via the clipboard.

DELETE: Deletes a file/folder

SORT: Sorts files by name, by time or by type.

FIND: Searches a file/folder. Enter the complete name or the first letter of the name. Call up the search function with the F key.

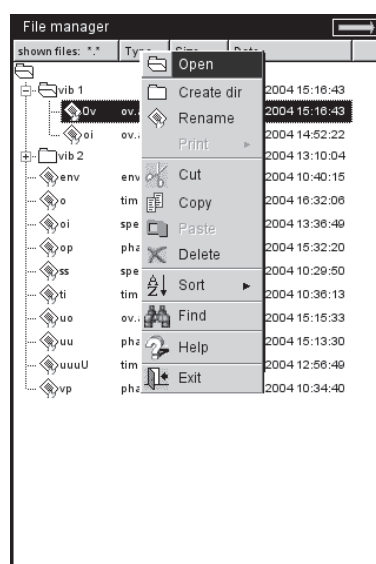
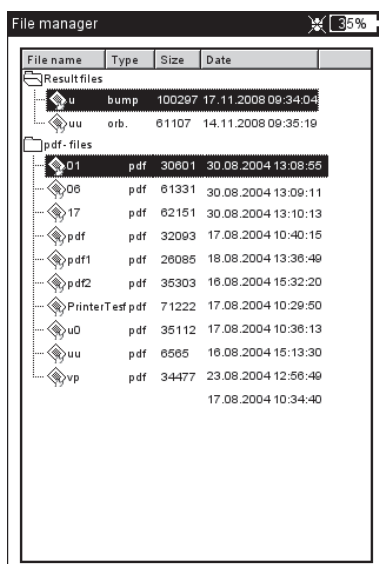

Left:

File Manager

contains result files and print files (PDF)

Right:

Open File

Printing out the PDF file

The print files saved in the PDF format can be printed as follows:

- Connect VIBXPRT EX to a printer.
- Open the File Manager and select the file to be printed.
- Press the MENU key and select 'Print > *Printer*'. Printing starts.

**Note**

Details on connecting and setting up a printer can be found in Chapter 2.

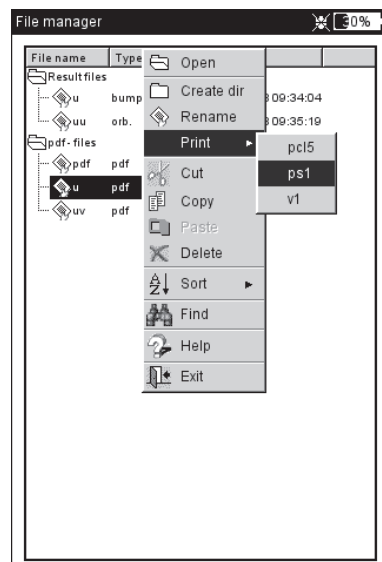
Print PDF file
Select printer

VIBXPRT utility

The 'VIBXPRT utility' tool can be used for the following tasks:

- Updating firmware (with the VIBXPRT update tool)
- Saving and restoring results and settings
- Formatting the CF memory card
- Export results in CSV format (Phase, Balancing, ODS analysis)
- Loading screen contents onto the PC.
- Loading PDF files onto the PC.
- Calling up the 'db spectra' program to convert narrow band spectra to third octave spectra.
- Converting spectra, time signals, impact tests and phase measurements to the UFF file format for evaluation in other analysis programs.
- Converting timewave recording measurement files to the IEEE format for further processing in the DASyLab analysis program.
- Transferring language and help files for translation (for authorized PRÜFTECHNIK representatives only).

Installing and starting the program

The installation program ('VIBXPRT_utility_version.exe') can be found on the PRÜFTECHNIK homepage (www.pruftechnik.com):

- Double click on the file to start the installation.
- Follow the instructions on the screen.
- To start the program, open the Windows START menu and select 'Programs / PRÜFTECHNIK Condition Monitoring / VIBXPRT utility / VIBXPRT utility'.

Alternative: In the installation directory* double click on 'vxpTool.jar'.

* C:\Programs\Pruftechnik\VIBXPRT EX\VIBXPRT EX utility



A start screen appears in which all available functions are accessible via buttons:



Show version number

Select language



Registration

Registering optional functions

The following functions are optional and must be enabled by a password:

- Conversion of measurement files into formats that can be processed by other analysis programs (UFF / IEEE)
- db Spectra for converting narrow band spectra to third octave spectra.
- To register, click on the 'Registration' button.
- In the screen that appears, enter the company name and, if already available, the corresponding password.
- To request a password, activate the desired function and click on 'Request registration'.

Enter password /
Request password

- In the next screen, check the entries and click on 'Print' to print out the data. Send the printout to the following fax number:
+49 89 99616300.
To send the data to PRÜFTECHNIK by eMail, click on 'eMail'.

Send / Print data for registration

- The password will be sent to you by fax or eMail within a short period of time.

Setting up a connection with VIBXPRT EX

Data transmission takes place via a network or USB connection.

- Connect VIBXPRT EX to the network or a PC.
- Click on the 'Connection' button.
- Set the type of connection (USB or Ethernet).
- *For Ethernet only:* Enter the IP address of the data collector in the network in the 'IP address' field.
- To test the connection, click on the 'Test communication' button. If the connection is working, a yellow 'Smiley' symbol appears. A red 'Smiley' symbol indicates a faulty connection.

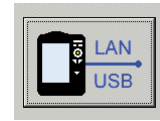

Connection

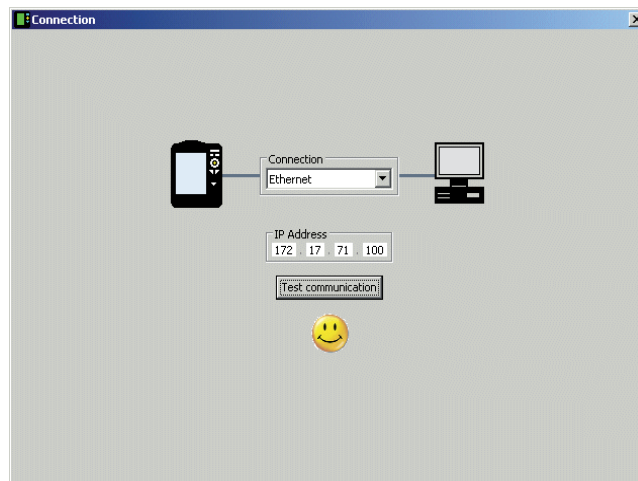

VIBXPRT EX successfully connected

Configuring VIBXPRT EX

The configuration encompasses the following functions:

- Updating the firmware
 - Transferring logo images for the report printouts
 - Transferring background images for the start screen
- Click on the 'Configure device' button.
 - The 'New firmware' button starts the 'VIBXPRT update tool' that updates the firmware in VIBXPRT EX.

The update tool must be installed in the designated directory on the PC:

C:\Programs\Pruftechnik\VIBXPRT\VxpUpdateTool

- Click on 'Report-Logo' button, to load a new logo image into VIBXPRT EX. The logo appears on each printed report page top right.
File requirements:
- Format: PNG / Size: 200 pixel (longest side)

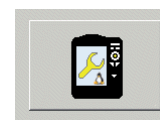

Device configuration



Report-Logo



- Click on the 'Background image' button.
- Select a background image for the VIBXPRT EX start window (format: PNG, size: 320x480 px, color: gray scale, 4-bit color depth) and load it into the device.

Deleting background images: Use 'Delete files' in the 'Service' menu.

- How to display the image in the start window is described in the 'Device Setup - Display' section.

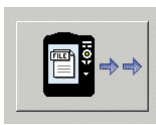

Get files

Transferring files

The following files can be transferred from the device to the PC:

- PDF files generated with a PDF printer driver.
- Screenshots generated by pressing <F> & <-> simultaneously .
- Results in CSV format for analysis and display in a spreadsheet program (eg MS Excel).



- Click on the 'Get files' button.
- Then click on the respective button and select the files you wish to transfer.
- Click on 'Transfer' to start the file transfer.
Use 'Delete' to remove a file from the device. 'Close' closes the file selection window.

File selection window

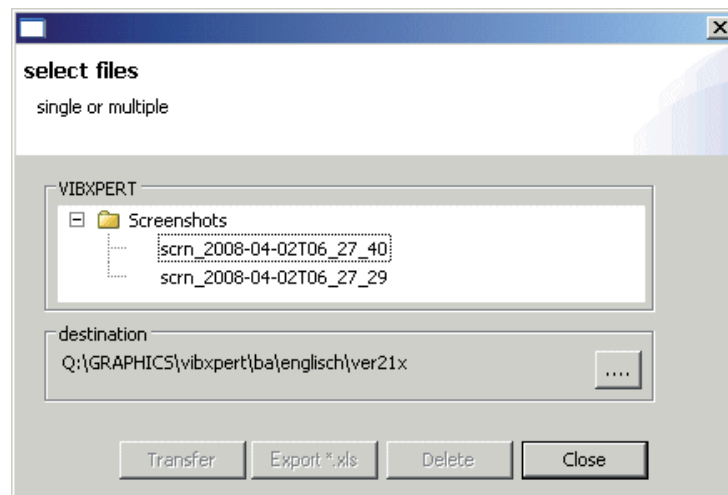

Transferring system files

You can perform the following procedures:

- Backup and restore of the data and device configuration
 - Format CF memory card.
 - All the above mentioned steps in a procedure ('Defragmentation').
- Click on the 'System' button.
 - To perform a data backup, click on 'Backup'.
 - In the screen that opens, select the data category (Settings / Results) and enter the target directory, if necessary.
 - Click on 'Backup' to start the procedure.
- The 'Restore' procedure is performed in the same manner.

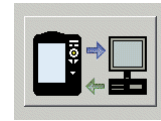

System

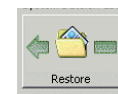
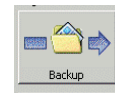

Backup settings

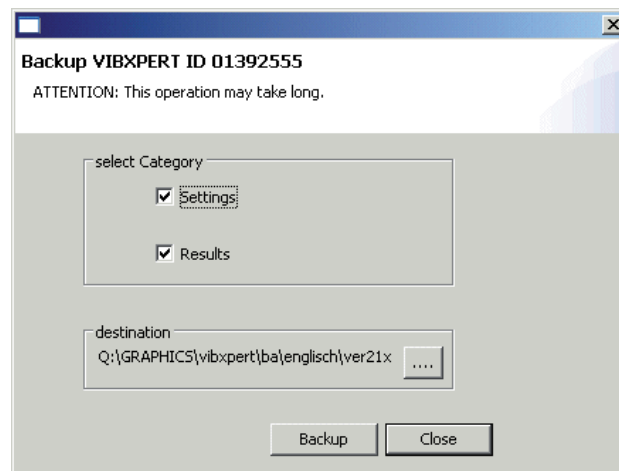

- Click on 'Format CF card' to format the memory card in the device.



Attention!

Risk of data loss!

Before proceeding, make sure that all important data and settings are backed up on an external storage device. Formatting deletes all data on the memory card. The process is not reversible!

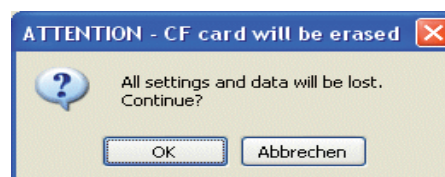

- Click on OK to start formatting.
- Click on 'Defragmentation' to perform the procedures 'Backup', 'Restore' and 'Format' in one step.



Defragmentation

VIBCODE

VIBCODE is a vibration measurement system that uses coded measurement points for certain identification of measurement locations on the machine. The system consists of the intrinsically safe VIBCODE sensor (VIB 8.660 HEX) and the VIBCODE measurement location.



Note

For further information, refer to the respective installation and operating manual (order no.: VIB 9.834.G)

Mechanical coding

VIBCODE sensor

The sensor head contains a piezoelectric accelerometer that measures the vibration signals via the measuring pin. Several pressure-sensitive sensors are arranged as a ring around the vibration sensor. When coupled to a measuring pin, these sensors detect the pattern in the plastic ring in the measuring pin. This coding identifies the measurement location to the connected evaluation device and determines which measurement tasks are to be performed on it.

VIBCODE measurement location

The measuring pin contains a plastic code ring that obtains a unique identity - similar to a fingerprint - through the removal of individual teeth.

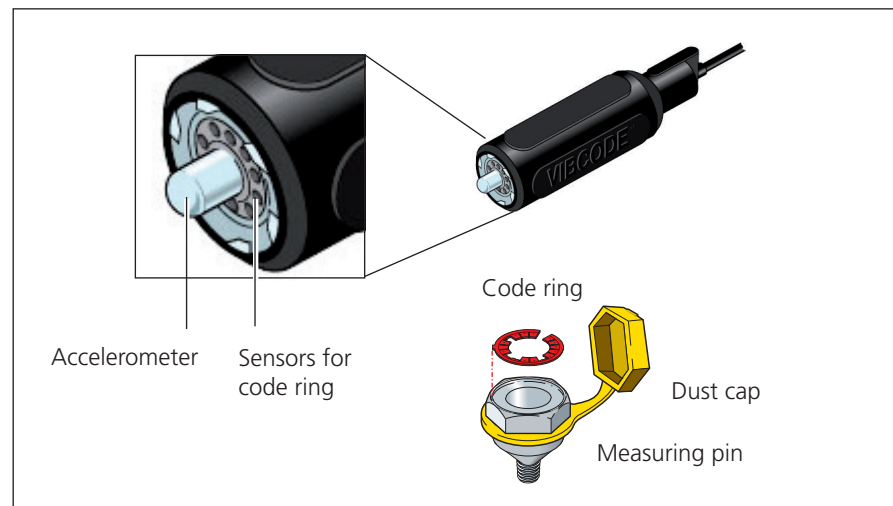

Coding ...

... or, "How are the measurement locations in the data base linked to the measurement locations onsite on the machine?"

The coding of the "mechanical" measurement locations is defined in the measurement location data base using the OMNITREND software and stamped into a special plastic ring using a tool. The coded ring is installed on the machine together with the measuring pin. This forms the link between the data base and the machine.

VIBCODE concept

... or, "What is the difference between a route and a pool?"

A machine park contains many VIBCODE measurement locations. However, not all measurement locations are measured with the same frequency since they are assigned different roles in the data base. Thus, the VIBCODE concept is structured as follows:

A: VIBCODE route

VIBCODE measurement locations at which measurements are taken regularly are part of a route. Because each route is created for a particular purpose (e.g. weekly inspection), it only contains a certain subset of all VIBCODE measurement locations. VIBCODE features automatic measurement location recognition so that the measurement locations can be visited in any order.

B: VIBCODE pool

A "pool" contains additional measurement locations that are measured on a route only if there is a special need. Pool measurement locations are loaded into the data collector together with the corresponding route.

C: Unknown VIBCODE measurement location

If the VIBCODE sensor is connected to a measurement location that is contained neither in the current route nor in an associated pool, VIBPERT EX interrupts the route. A measurement can only be performed in the 'Multimode' (see also next page).

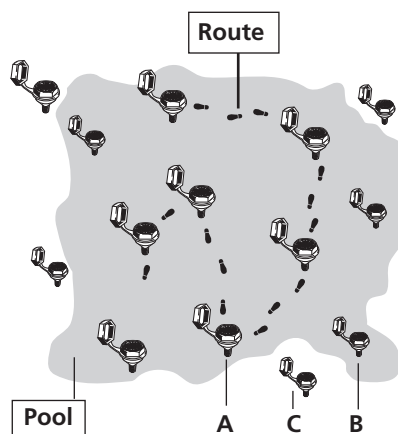

Measuring with VIBCODE



Never use the VIBCODE sensor to take a measurement directly from the machine surface. This sensor must always be locked onto the measuring pin!

Do not remove the VIBCODE sensor neither from the VIBCODE measurement location nor from VIBXPERT EX during measurement.

Connecting the VIBCODE sensor

Insert the sensor straight into the measurement location, press it in place lightly and lock it by turning it clockwise until it stops.

This secure connection ensures that the measurement direction and pressure are the same for each measurement and that the results are reproducible.

To disconnect the sensor, turn it in the opposite direction and remove it from the measurement location.

Connect the sensor cable to the measurement channel that is set in the measurement task (A or B).

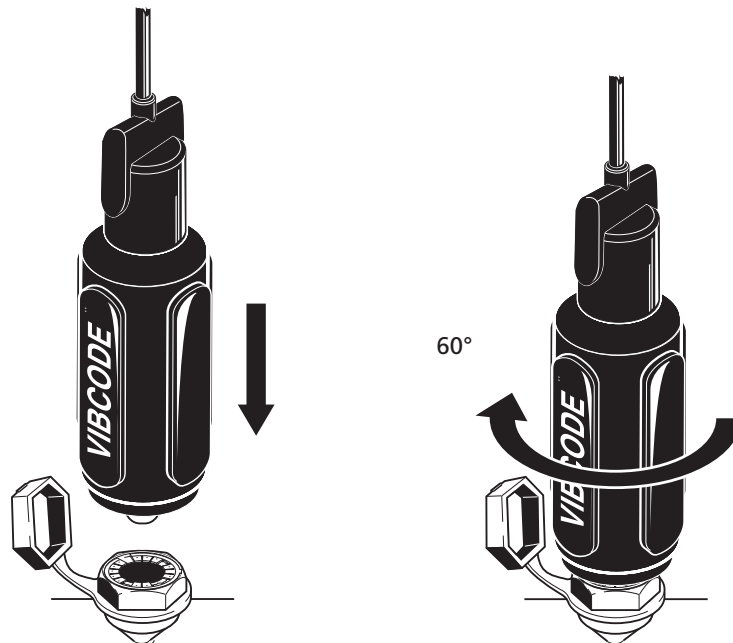

Measuring VIBCODE Route/ Pool

- Click on 'Route' in the start screen.
- Open the route to be measured.
- Connect the VIBCODE sensor to a VIBCODE measurement location:

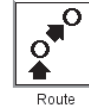

VIBXPRT EX reads the coding of the measurement location and checks if this is created in the route. If VIBXPRT EX finds a measurement task, measurement starts automatically. If all measurement tasks at the measurement location are complete, plug the VIBCODE sensor into the next VIBCODE measurement location and continue measurement of the route.

VIBCODE in Route

If VIBXPRT EX finds the measurement location in the VIBCODE pool, the measurement task scheduled first starts automatically. All other measurements must be triggered manually via the measurement task selection.

VIBCODE in Pool

To return to route mode from pool mode, press the MENU button and click on 'Route'.

If the VIBCODE measurement location is not contained in either the route or in the pool, change to the 'Multimode' mode to perform the required measurement. To do so, click on 'Multimode' in the message window or press the MENU button and click on 'Multimode'. Under certain circumstances it may be necessary to change the transducer in the task manager to 'VIBCODE' beforehand. After saving the measurement result, repeatedly press the ESC button to return to the route mode.

Unknown VIBCODE

Unknown VIBCODE location

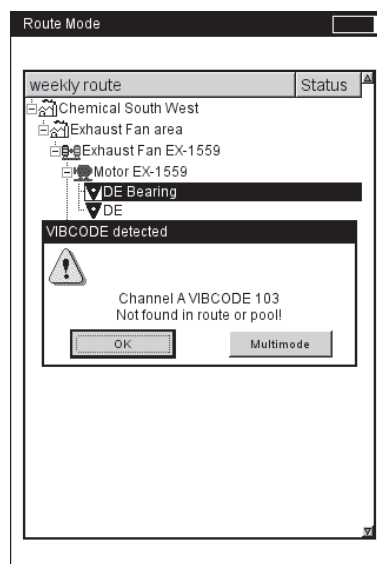

* The carrying pouch is only available for devices without explosion protection.

Technical notes

VIBXPERT EX is a precision instrument and should be treated as such.

Storage

If VIBXPERT EX is not used for lengthy periods, stow the device in the case and connect it regularly to the mains to avoid the battery from completely discharging.

Make sure that

- the storage location is dry
- the measurement device is not stored near electronic equipment which can generate strong electromagnetic fields.
- the measurement instrument is not exposed to temperatures above 70°C / 156°F or under -20°C / -4°F.
- the humidity is not more than 90%.

Cleaning

If lightly soiled, the housing can be wiped with a damp cloth. In cases of more stubborn soiling, use a household cleaner.

The display can be cleaned using a soft dry cloth.



Attention!

Never use solvents or other strong cleaning agents

Maintenance

Various factors such as aging or temperature can cause an offset in the analog electronics. This offset should be compensated every two months.

To guarantee the high measurement accuracy of the device, VIBXPERT EX requires accuracy checks every two years. The respective date is indicated on the colored sticker on the rear of the measurement instrument. A couple of months before the next accuracy check a warning will appear on the display when the instrument is switched on. Send the device to your PRÜFTECHNIK representative.

Before you send the unit in for repairs or accuracy checks, transfer the measurement data to the OMNITREND software. Afterwards, conduct a backup. For data backup, use the program VIBXPERT utility.

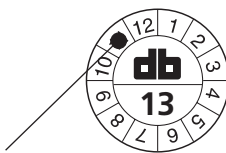

Next check: November 2013



Attention!

For safety reasons, do not send units if the battery is obviously defective or if you suspect a defect in the battery!

Guarantee

The measurement device has a guarantee period of 1 year. Any guarantee claims expire if service work is carried out by non-authorized personnel.

Spare parts, accessories

Only original spare parts and accessories may be used. Information on these parts is given in the VIBXPERT product catalog. The current edition can be downloaded from the PRÜFTECHNIK website.

Disposal

Dispose of the device and the spare parts at the end of its lifetime according to the applicable environmental regulations.

The battery must be discharged when the device is disposed of. The battery is discharged when the charging display is completely white and the message 'Battery empty' appears on the display.



Attention!

The following information applies to customers in member states of the European Union (EU) in which EU Directive

2002/96/EG "Waste Electrical and Electronic Equipment" (WEEE)

has been implemented in national law:

PRÜFTECHNIK products that fall under this directive are labeled with the symbol shown here.

What this means for you:

- All electrical and electronic PRÜFTECHNIK products and electrical and electronic accessories (e.g. cables, sensors, etc.) must henceforth be disposed of with PRÜFTECHNIK or their authorized disposal partner. Under no circumstances may these products be disposed of in household or municipal waste.
- Information on the waste disposal partner to whom you can turn when you wish to discard your equipment is available from the following sources:
 - your PRÜFTECHNIK sales partner
 - your authorized PRÜFTECHNIK dealer

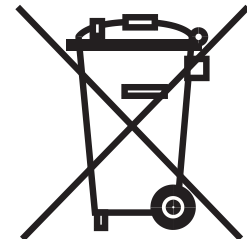

PRÜFTECHNIK Condition Monitoring
WEEE-Reg.-No.: DE 72273578

Technical data

PARAMETER		VIB 5.300 EX
Input Channels	Analog, 2x	Voltage (AC/DC, ± 30 V max.) Current (AC/DC, ± 30 mA max.) ICP-type accelerometer (2 mA, 24 V max.) Current Linedrive (CLD) accelerometer (10 V, 10 mA max.)
	Frequency range	DC ... 51.2 kHz (Acceleration from 0.5 Hz)
	Dynamic range	96 dB (measurement) / 136 dB (total)
	Sampling frequency	up to 131 kHz per channel
	Analog, 1x	Thermocouple (type K)
	Digital (1+1 Pulse/ Tacho), 1x	RPM, Trigger, Keyphaser with pulse and AC signals: 0 V ... +26 V or -26 V ... 0 V
	Max. input voltage	± 26 V
	Switching threshold for 0 V ... +26 V signal	max. 2.5 V rising, min. 0.6 V falling
	Switching threshold for -26 V ... 0 V signal	min. -8 V rising, max. -10 V falling
	Pulse width	< 0.1 ms
Output Channels	Stroboscope control	TTL output
	Frequency range	0 ... 500 Hz
	Resolution	0.05 Hz
	Signal-Out	Connection for headphones to listen to the analog input signal; signal processing (oscilloscope)
	Frequency range	0.5 Hz ... 40 kHz
Output impedance	100 Ohm	
Meas. range / Accuracy	Vibration acceleration	depends on the transducer connected
	Shock pulse	-10 ... 80 dBsv / ± 3 dBsv
	RPM	10 ... 200 000 min ⁻¹ / $\pm 0.1\%$ or ± 1 min ⁻¹ (the lower accuracy is applicable)
	Temperature type K	-50 ... +1000°C / 1% or ± 1 °C (the lower accuracy is applicable)
	Standards fulfilled	Frequency response according to ISO 2954

PARAMETER		VIB 5.300 EX
Display	Type	LCD, backlit
	Pixel area	115 x 78 mm
	Resolution	1/2 VGA (480 x 320 pixel)
	Color depth	16 grey scales
Power supply	Battery type	Li Ion rechargeable battery pack (7.2V / 4.8Ah - 34 Wh)
	Charging time	< 5 hours in the device or external with optional charging station
	Charger, input	110-240 V / 50-60 Hz
	Charging temperature	0°C ... +50°C
Computer	Processor	Intel Strong ARM 206 MHz
	Keyboard	2 joysticks and 12 keys for right-hand or left-hand operation. Keyboard illumination controlled by ambient light.
	Memory	Internal: 64 MB RAM; Compact Flash: 1 GB or 4 GB
	Serial interface	RS 232, <115 kBaud
	USB interface	USB host for printing; USB slave for data exchange with OMNITREND
	Ethernet interface	10 Mbit (10Base T)
	Printing	Direct printing of measurement reports via the USB port Compatible printer types: HP, Epson and other printers with USB connection
Environment / General	Connectors	Analog / Digital channels: MiniSnap socket Thermocouple (type K): QLA socket; all compatible to VIBSCANNER
	Housing	Aluminium
	Dimensions	250 x 220 x 37 mm (LxWxH)
	Weight	approx. 2.3 kg
	IP rating	IP65, dust and splash-proofed
	Temperature range	-10°C ... +60°C (Operation) -20°C ... +60°C (Storage)
	Intrinsic safety	Ⓔ II 2 G Ex ib IIC T4

Troubleshooting

Symptom:

VIBXPert EX will not start up. The start procedure is not executed completely, the display stops at the screen showing the LINUX penguin.

Cause:

Failure in the flash memory.

Solution:

Reload the firmware.

Reloading firmware

Before reloading the firmware, ensure that the following components are at hand or installed on the PC:

- VIBXPert EX update tool version 1.47 or higher.
- Communication adapter for VIBXPert EX (VIB 5.330-UNV)
- Connect VIBXPert EX to the serial port and to the network connector of the PC. Use the communication adapter.
- Start the VIBXPert update tool on the PC.

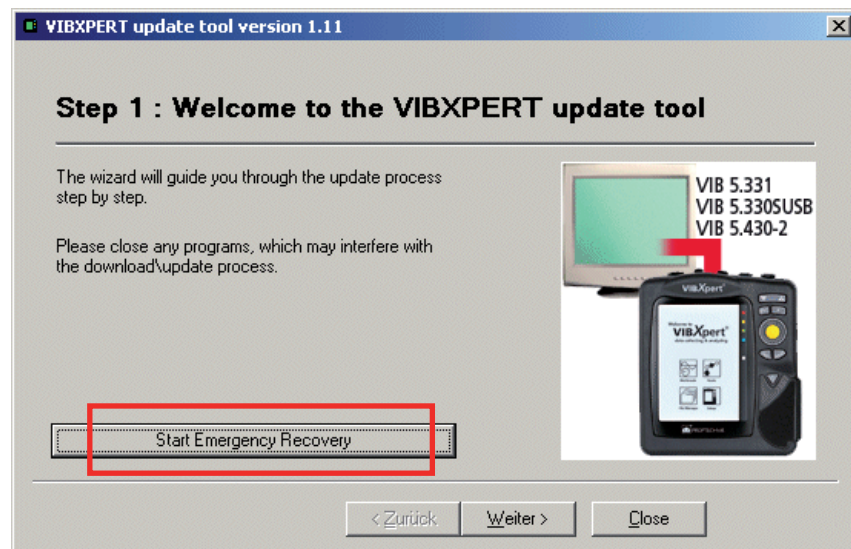

- Click on the 'Start Emergency Recovery' button. A warning is issued that the following process deletes all data on the memory card. Confirm to continue, or save the card content before confirming.
- In the next screen, set up the COM port to be used on the PC and enter the IP address that is to be used by VIBXPert EX. If the IP address of the PC is not identified automatically, enter it in the appropriate field.

- Click on OK.

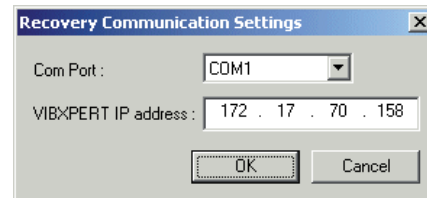

- Switch VIBXPERT EX off and on again.
The update tool subsequently contacts VIBXPERT EX and starts transfer of the basic firmware. The progress of the data transfer is shown in the right pane: 'Transferring data X%'

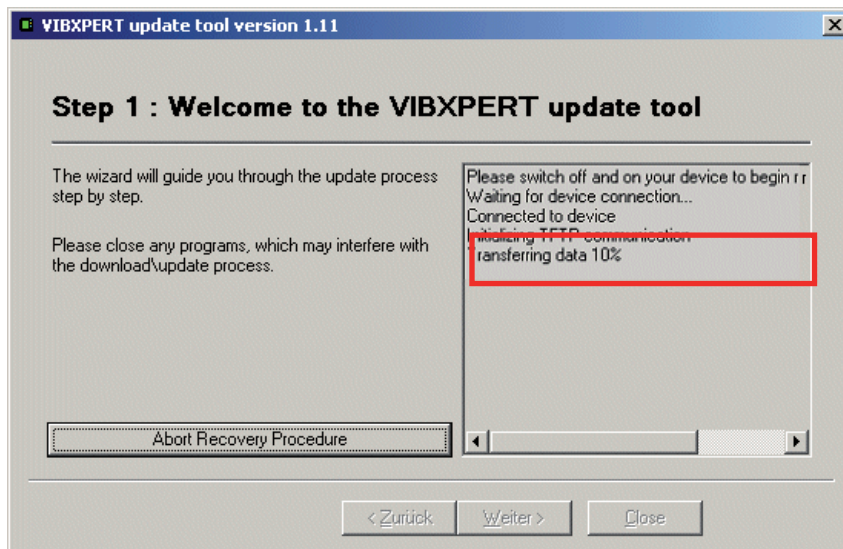

- Then it is only necessary to load the firmware: To do this, follow the instructions in section 'Update' in chapter 2.

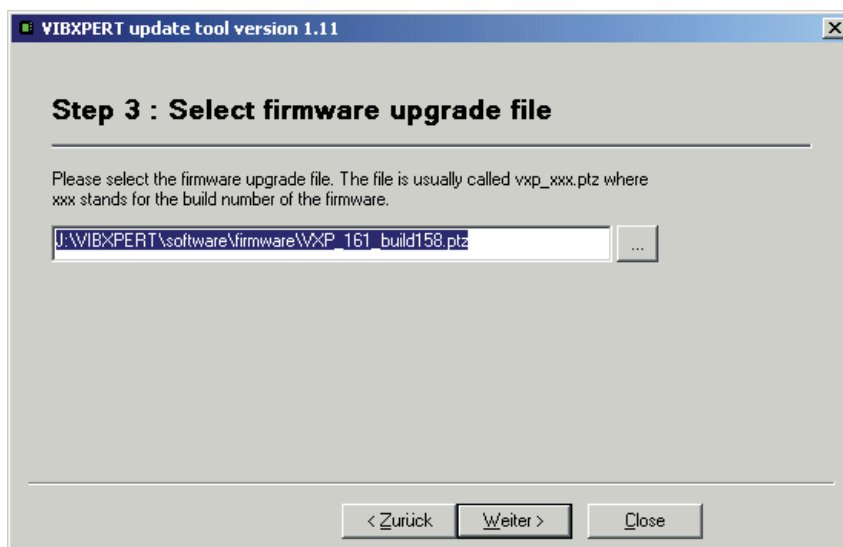

Index

Symbole

- 1+1 measurement (Dual) 131
- 3D display 99
- +/- key 16

A

- Accessories 153
- Active Hierarchy 25
- Adaptive task 54, 60
- Amplitude spectrum 99
- Analog Out / Headphone
 - Configuration 38
- Angle direction 103
- Angle type 103
- Append result 77
- AutoSave 26, 28
- Average overlap 69
- Averaging type 69, 72

B

- Bandalarms 95
- Basic settings 22
- Battery icon, display 20
- Bearing condition 110
- Bode plot 117
- Break down multitask 58

C

- Calibration 152
- Cepstra analysis 127
- Changing the measurement channel 65
- Circular plot 91
- Cleaning
 - VIBXPRT 152
- Coastdown 114
- Communication 19, 44
- Continuous measurement 52, 101
- Continuous phase 103
- Crest factor 109
- Cross Channel phase 122
 - Coherence 123
- Cursor 90, 96, 98, 102

D

- Date 22
- Daylight saving 22
- dB scaling 41
- DC measurements 138
- Default vibration sensor 32
- Delete files 41, 141
- Demo 40
- Demodulation factor 71
- Device Info 39
- Device Setup 22

- Diagram type 102, 125
- Display mode 102
- Display settings
 - Route 24
- Disposal 153
- Dual task (1+1) 131

E

- Editor
 - number 139
 - text 140
- Envelope analysis 126
- Evaluation 88
 - overall values 73
 - timewaveform 73
- Event 74

F

- Factory Defaults 39
- File Manager 141
- Filter - HP/LP 71
- Filter Type 71
- Find 141
- Find (route) 59
- Firmware, re-installing 156
- Formatting 41
- Frequency marker 95
- Frequency, upper/lower 69

G

- Graphic Route 28
- Guarantee 152

H

- Harmonics cursor 98
- Historical data 78
- HP/LP Filter 71

I

- Icons 57
- Impact test 133
- Impulse hammer 135
- Independent values
 - Phase trend 104
- Input voltage range 30
- Interfaces 18
- Intrinsically safe version
 - nameplate 14
- Intrinsic safe version
 - Interface parameters 13
- ISO 10816-3 109

K

- Key controls 35
- Keyphaser 33

L

- Language 33
- Laser trigger sensor 112
- LED-Anzeige 16, 17
- Linear from / to 30
- Lines 72
- List view 56
- Live mode 52, 101
- LogLevel 40
- Lower / Upper Frequency 71

M

- Machine templates 49, 61
- Maintenance 152
- Manual entry 54
- Measurement 51
 - abort 65
 - channel, changing 65, 66
 - quantity 30
 - range 70
 - rate 119
 - repeat 65
 - report 106
 - task 50, 109
 - manager 67
 - new 67
 - user-defined 127
 - time 69, 72
 - type 50, 69
- Measurement value
 - deviation 79
- Memory card 41
- Modal analysis 135
- Multi meas. task 128
- Multimode 49
- Multitask optimize 26

N

- Near location 80
- Negative average 70, 134
- Network communication 44
- Network connection 43
- Normalization, dB_i, dB_a 110
- Number editor 139
- Number of lines 72

O

- ODS - Operating Defl. Shape 135
- Offset 30
- Offset Compensation 39
- Options - Measurement 65
- Orbit 124
- Order 69, 70
- Order-based spectrum 137
- Order filter 123

Order scaling 102
 Order spectrum 137
 Overall value 88
 calculating 91
 Display setup 101
 Overall vibration 109
 Overlap 69

P

Parameters
 Evaluation 73
 Measurement setup 69, 71
 RPM measurement 73
 transducer 29
 Patch connection 43
 PC licence 34
 Phase measurement 122
 Phase over 104
 Phase trend 123
 Plot type 103
 Pool 59
 Post-Processing 97
 Power supply 20
 Print 105
 Printer 36
 Pulse per rev. 69

R

Rechargeable battery 20
 Recording 82
 Reference data 78
 Referenzflanke 33
 Registration 33
 Repair CF card 41
 Report
 Measurement 106
 Route / Template 108
 Report-Logo 145
 Resonance frequency 31
 Result
 Details 88
 print 105
 RMS, show 97
 Route 55
 Display settings 24
 Graphic 28
 Report 108
 Runtime setup 59
 Setup 24
 RPM deviation 119
 RPM entry, manual 66
 RPM range 70
 RPM run 92
 Runtime setup 59
 Runup / Coastdown 114

S

Safety 10
 Sampling rate 69, 71
 Save 35, 52, 141
 Scaling 90
 Screenshot 105
 Search 141
 Sensor angle 71
 Sensor check 32
 Sensor detection 27
 Serial connection 42
 Service addresses 9
 Service menu 39
 Settling time 31
 Setup
 new 68
 Shaft centerline plot 120
 Shock pulse 110
 Sidebands 91, 98
 Signal
 Display-Setup 102
 Signal type 30
 Skip 60
 Spare parts 153
 Spectrum 99
 calculating 92
 Speed Marker 102
 Start measurement
 Machine template 63
 Multimode 51
 Route 55
 Start Route 55
 Start-Stop, RPM
 Runup/ coastdown 70
 Static shaft position 121
 Storage 152
 Stroboscope 97
 Subharmonics 98
 Switching on 21
 Symbols 10

T

Task manager 67
 Technical notes 152
 Temperature meas. 113
 Text editor 140
 Time 22
 Time format 22
 Time-synchronous average 69, 93
 Time waveform recorder 86
 Time zone 22
 Transducer
 new 31
 Parameter 29
 used in 29

Tree view 56
 Trend 103
 Display-Setup 103
 measurement 76
 TrendingSpectrum 137
 Trending values 96
 Trigger 70
 Trigger sensor 112
 Troubleshooting 156

U

Units 34
 Unskip 60
 Update 46

V

VIBCODE 148
 handling 27
 Pool 149, 151
 Route 151
 Unknown location 149
 VIBXPRT
 Technical notes 152
 VIBXPRT PC license 34
 VIBXPRT utility 143
 Visual inspection 54

W

Waterfall diagram 99
 WEEE 153
 Window 70, 72

Z

Zoom 90, 102

**Productive
maintenance
technology**

Fluke Deutschland GmbH
Freisinger Str. 34
85737 Ismaning, Germany
+ 49 89 99616-0
www.pruftechnik.com

Printed in Germany VIB9.805.01.2017.0G